

Rodless cylinders - Series 52

Product code: 52R8C40A0970

Datasheet creation date: 08/03/2025 12:36

Check the most updated document online [click here](#)



TECHNICAL DATA

Series	52R8C40A
Diameter (mm)	40
Version	R = with roller bearing
Operation	8 = double-acting, cushioned, with air supply from one side only
Materials	C = anodized AL profile, NBR and Polyurethane seals, short carriage
Construction	A = standard
Stroke Cylinder (mm)	970

Rodless cylinders - Series 52

Product code: 52R8C40A0970

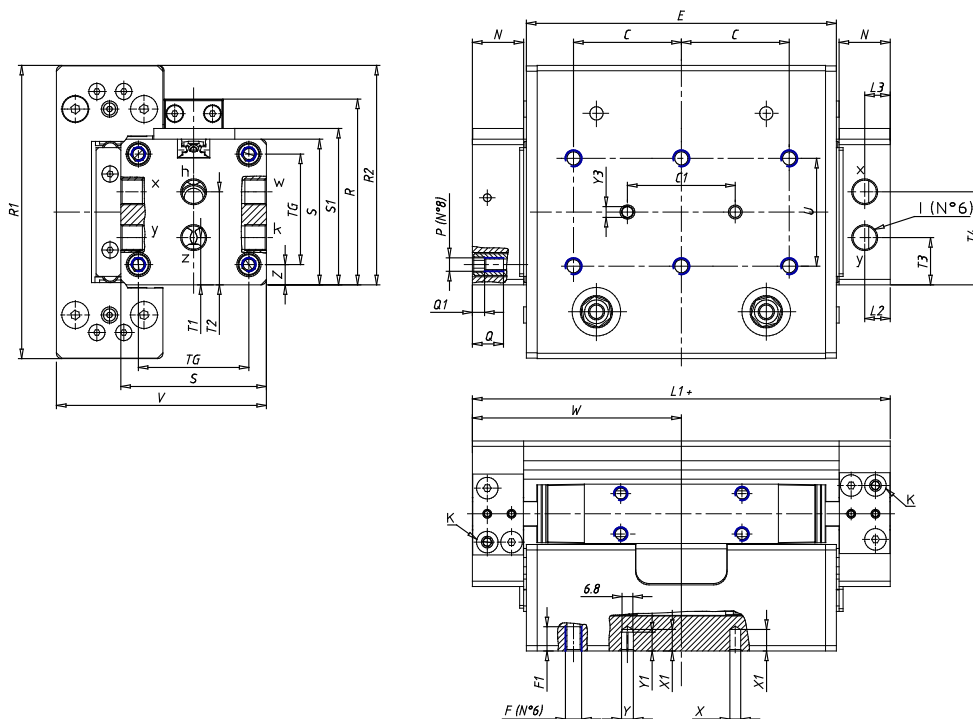

DIMENSIONS

W (mm)	95.0
E (mm)	143.5
L1 (mm)	190
I	G1/4
B (mm)	0
G (mm)	6.5
N (mm)	23
L (mm)	11.5
Ø A (mm)	0.0
Ø X (mm)	6.0
S1 (mm)	68
T (mm)	38.0
Z (mm)	7.5
C1 (mm)	40
C (mm)	55
U (mm)	55
F	M5
F1 (mm)	12.0
H (mm)	0.0
V (mm)	90.5
S (mm)	64
R (mm)	82
P	M6

TG (mm)	49
Q (mm)	12
Q1 (mm)	4
T1 (mm)	15.5
T2 (mm)	38.0
T3 (mm)	20.5
T4 (mm)	42.5
L2 (mm)	11.5
L3 (mm)	11.5
D (mm)	10.5
M (mm)	4.5
J	-
JP (mm)	0.0
J1 (mm)	0
R1 (mm)	100.0
X1 (mm)	8.0
Y (mm)	6.5
Y1 (mm)	7.0
Y2 (mm)	6
Y3 (mm)	6
R2 (mm)	104.5