

Ball screw electromechanical axis - Series 5E-SBS

Product code: 5ES050BS05P0200AS1

Datasheet creation date: 20/05/2026 01:53

Check the most updated document online [click here](#)



TECHNICAL DATA

Series	5E
Profile	S = square section
Size	050
Transmission	BS = ball screw
Screw pitch	05P = 5mm
Stroke (mm)	200
Version	A= standard axis
Type of slider	S = Standard
Number of sliders	1= 1 slider

Ball screw electromechanical axis - Series 5E-SBS

Product code: 5ES050BS05P0200AS1

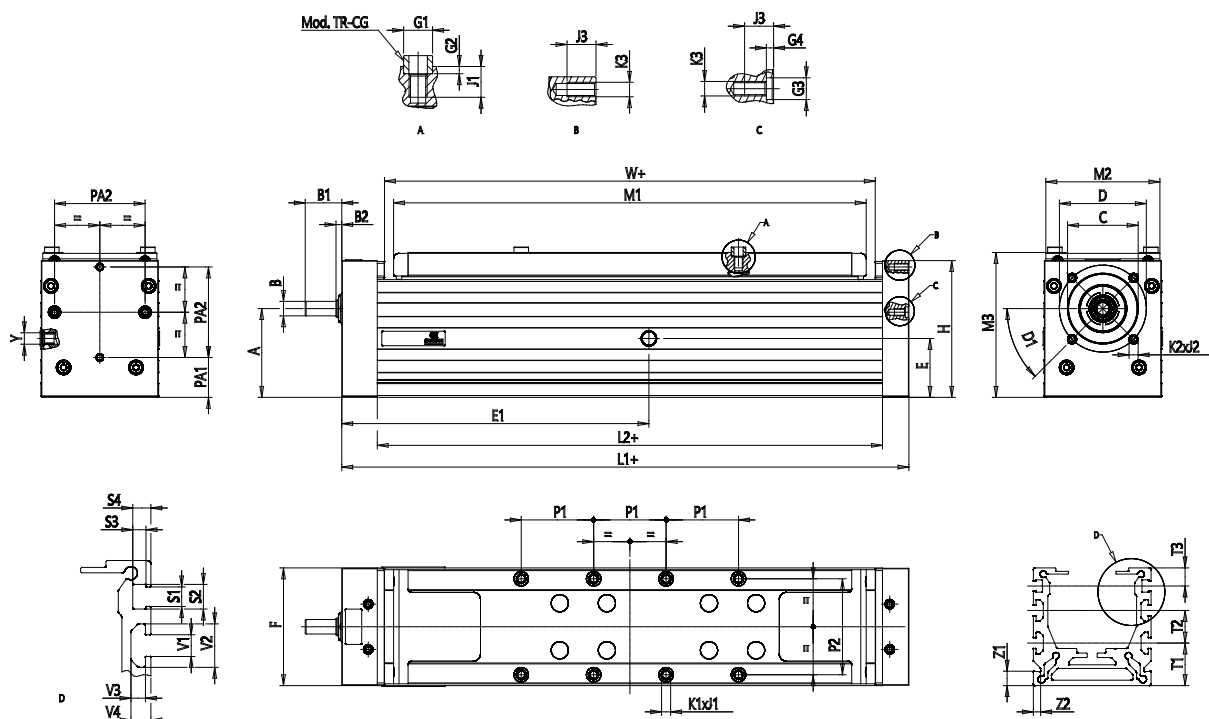

DIMENSIONS

A (mm)	36.7
B (H7) (mm)	8
B1 (mm)	22.3
B2 (mm)	5.3
C (mm)	30
D (mm)	38
D1 (°)	90
E (mm)	32
E1 (mm)	141.0
F (mm)	50
G1(H8) (mm)	6
G2 (mm)	2
G3 (mm)	6
G4 (mm)	2
H (mm)	60.5
L1 (mm)	264
L2 (mm)	232.0
M1 (mm)	214
M2 (mm)	48
M3 (mm)	65
P1 (mm)	30
P2 (mm)	40
PA1 (mm)	17

PA2 (mm)	40
K1	M4
J1 (mm)	8
K2	M4
J2 (mm)	6
K3	M4
J3 (mm)	6
T1 (mm)	20.0
T2 (mm)	0
T3 (mm)	10
V (mm)	6
Y	6.3
W (mm)	224.0
Z1 (mm)	8
Z2 (mm)	4
Weight stroke zero (kg)	2.00
Stroke weight per meter (kg)	4.07