

## Ball screw electromechanical axis - Series 5E-SBS

Product code: 5ES050BS10P1000AS1

Datasheet creation date: 07/03/2025 16:31

Check the most updated document online [click here](#)



### TECHNICAL DATA

<b>Series</b>	5E
<b>Profile</b>	S = square section
<b>Size</b>	050
<b>Transmission</b>	BS = ball screw
<b>Screw pitch</b>	10P = 10mm
<b>Stroke (mm)</b>	1000
<b>Version</b>	A= standard axis
<b>Type of slider</b>	S = Standard
<b>Number of sliders</b>	1= 1 slider

## Ball screw electromechanical axis - Series 5E-SBS

Product code: 5ES050BS10P1000AS1

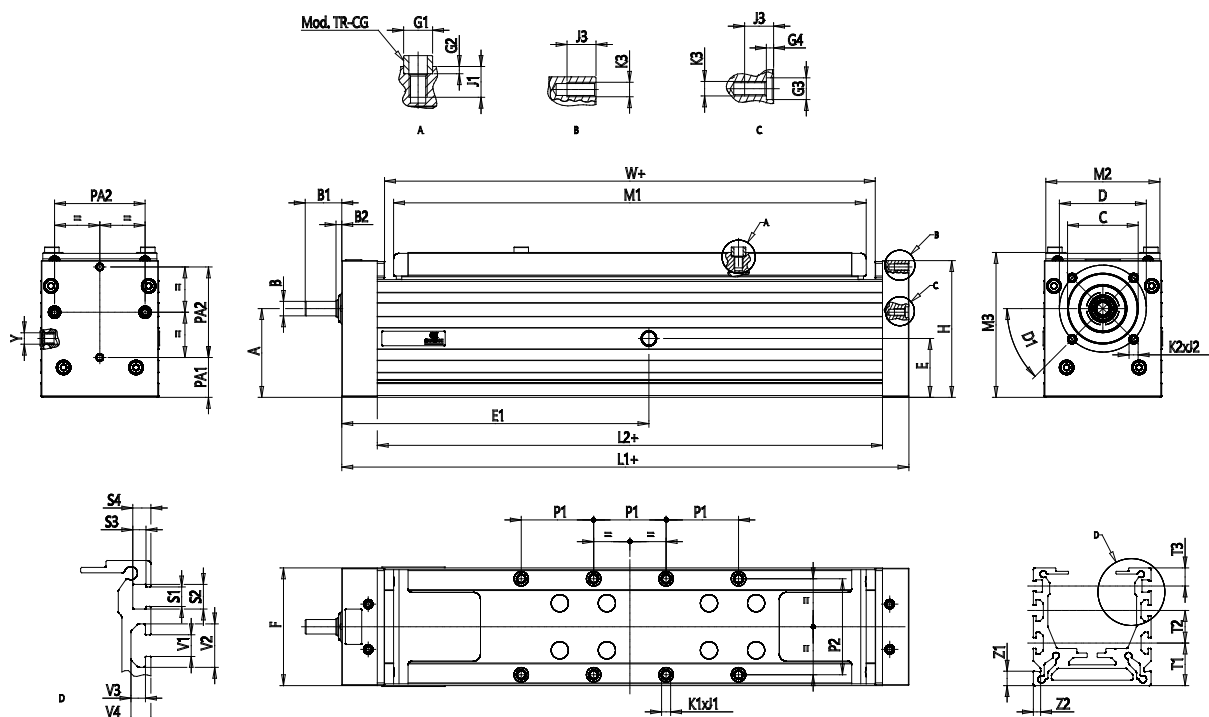

### DIMENSIONS

A (mm)	36.7
B(H7) (mm)	8
B1 (mm)	22.3
B2 (mm)	5.3
C (mm)	30
D (mm)	38
D1 (°)	90
E (mm)	32
E1 (mm)	141.0
F (mm)	50
G1(H8) (mm)	6
G2 (mm)	2
G3 (mm)	6
G4 (mm)	2
H (mm)	60.5
L1 (mm)	264
L2 (mm)	232.0
M1 (mm)	214
M2 (mm)	48
M3 (mm)	65
P1 (mm)	30
P2 (mm)	40
PA1 (mm)	17

PA2 (mm)	40
K1 (mm)	M4
J1 (mm)	8
K2 (mm)	M4
J2 (mm)	6
K3 (mm)	M4
J3 (mm)	6
T1 (mm)	20.0
T2 (mm)	0
T3 (mm)	10
V (mm)	6
Y	6.3
W (mm)	224.0
Z1 (mm)	8
Z2 (mm)	4
Weight stroke zero (kg)	2.00
Stroke weight per meter (kg)	4.07