

Belt electromechanical axis - Series 5E-TBL

Product code: 5ES050TBL0800AS1

Datasheet creation date: 07/03/2025 16:28

Check the most updated document online [click here](#)



TECHNICAL DATA

SERIE (Series)	5E
PROFILO (Profile)	S = square section
TAGLIA (Size)	050
TRASMISSIONE (Transmission)	TBL = toothed belt
VERSIONE (Version)	A= standard axis
TIPOCURSORE (Type of slider)	S= standard
NUMEROCURSORI (Number of sliders)	1= 1 slider
CL (CL / mm)	0
CORSA (Stroke)	800

Belt electromechanical axis - Series 5E-TBL

Product code: 5ES050TBL0800AS1

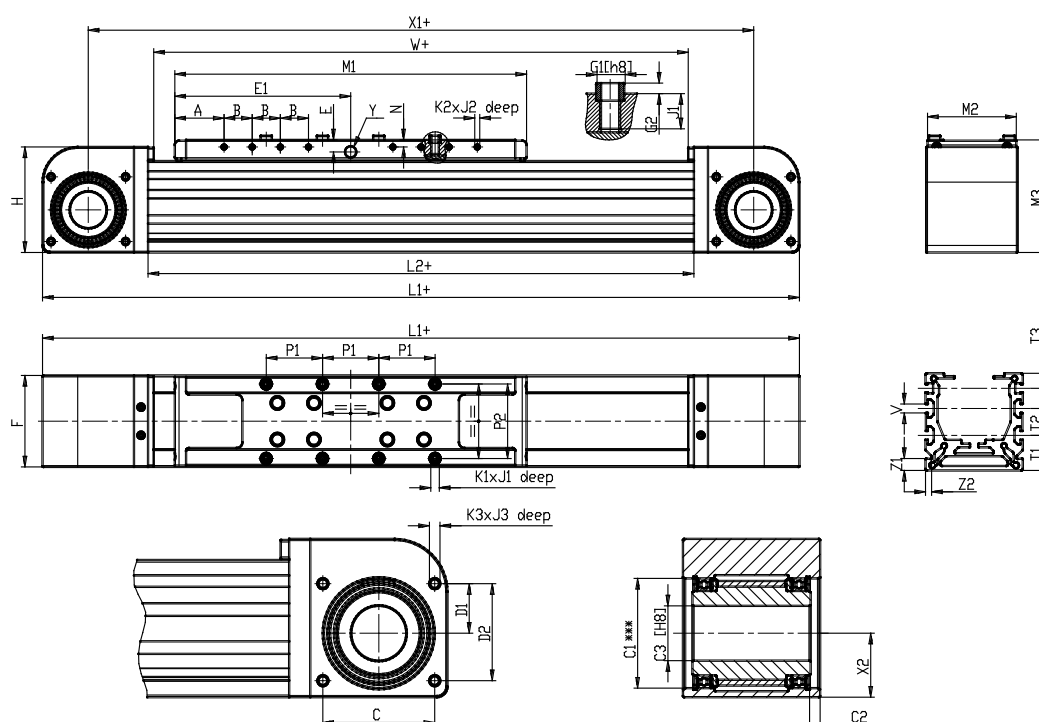

DIMENSIONS

A (A / mm)	32.5
B (B / mm)	15
C (C / mm)	37
C1 (C1 / mm)	37
C2 (C2 / mm)	4.5
C3 (C3 / mm)	20
C4 (C4 / mm)	25
C5 (C5 / mm)	46
D1 (D1 / mm)	17.0
D2 (D2 / mm)	32.0
E (E / mm)	8.5
E1 (E1 / mm)	100.0
E2 (E2 / mm)	62
F (F / mm)	50
F4 (F4 / mm)	2
G1 (Ø G1 / mm)	6
G2 (G2 / mm)	2
H (H / mm)	60
L1 (L1 / mm)	354
L2 (L2 / mm)	238
M1 (M1 / mm)	200
M2 (M2 / mm)	48
M3 (M3 / mm)	65

M4 (M4 / mm)	180
N (N / mm)	5
P1 (P1 / mm)	30
P2 (P2 / mm)	40
P3 (P3 / mm)	23
P4 (P4 / mm)	20.0
K1 (K1 / mm)	M4
J1 (J1 / mm)	7
K2 (K2 / mm)	M3
J2 (J2 / mm)	5.0
K3 (K3 / mm)	M4
J3 (J3 / mm)	8
T1 (T1 / mm)	20.0
T2 (T2 / mm)	0.0
T3 (T3 / mm)	10
V (V / mm)	6
Y (Y)	**
X1 (X1 / mm)	304
X2 (X2 / mm)	21.8
W (W / mm)	230
Z1 (Z1 / mm)	8
Z2 (Z2 / mm)	4
U (U / mm)	21.8