

## Belt electromechanical axis - Series 5E-TBL

Product code: 5ES050TBL1350AS1

Datasheet creation date: 07/03/2025 16:29

Check the most updated document online [click here](#)



### TECHNICAL DATA

<b>SERIE (Series)</b>	5E
<b>PROFILO (Profile)</b>	S = square section
<b>TAGLIA (Size)</b>	050
<b>TRASMISSIONE (Transmission)</b>	TBL = toothed belt
<b>VERSIONE (Version)</b>	A= standard axis
<b>TIPOCURSORE (Type of slider)</b>	S= standard
<b>NUMEROCURSORI (Number of sliders)</b>	1= 1 slider
<b>CL (CL / mm)</b>	0
<b>CORSA (Stroke)</b>	1350

## Belt electromechanical axis - Series 5E-TBL

Product code: 5ES050TBL1350AS1

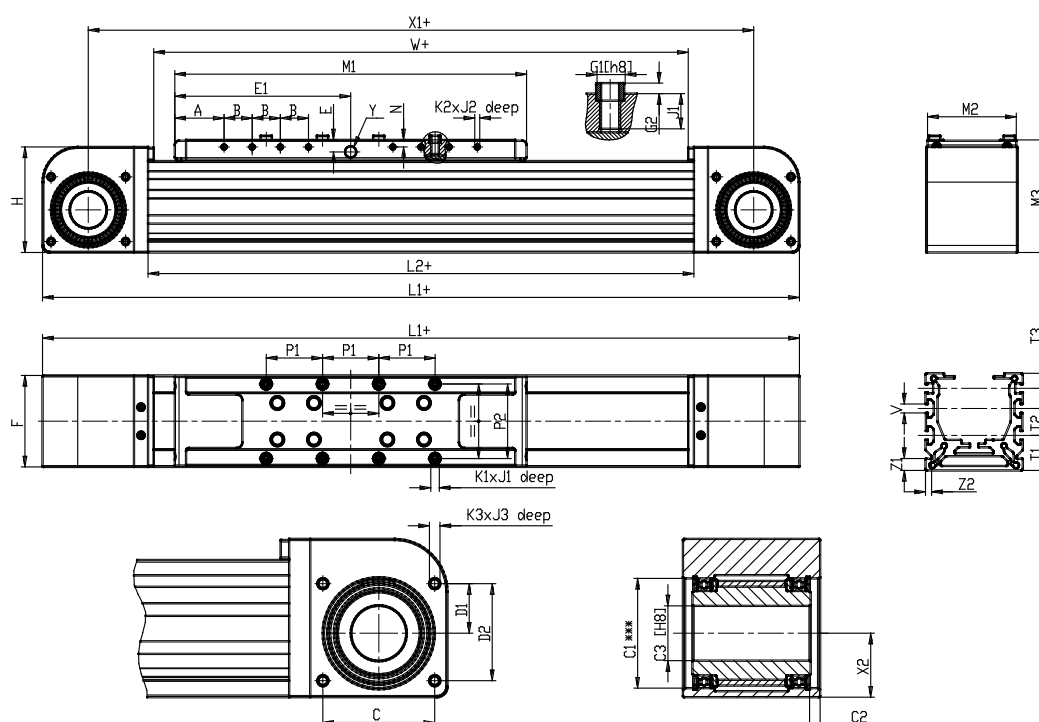

### DIMENSIONS

<b>A (A / mm)</b>	32.5
<b>B (B / mm)</b>	15
<b>C (C / mm)</b>	37
<b>C1 (C1 / mm)</b>	37
<b>C2 (C2 / mm)</b>	4.5
<b>C3 (C3 / mm)</b>	20
<b>C4 (C4 / mm)</b>	25
<b>C5 (C5 / mm)</b>	46
<b>D1 (D1 / mm)</b>	17.0
<b>D2 (D2 / mm)</b>	32.0
<b>E (E / mm)</b>	8.5
<b>E1 (E1 / mm)</b>	100.0
<b>E2 (E2 / mm)</b>	62
<b>F (F / mm)</b>	50
<b>F4 (F4 / mm)</b>	2
<b>G1 (Ø G1 / mm)</b>	6
<b>G2 (G2 / mm)</b>	2
<b>H (H / mm)</b>	60
<b>L1 (L1 / mm)</b>	354
<b>L2 (L2 / mm)</b>	238
<b>M1 (M1 / mm)</b>	200
<b>M2 (M2 / mm)</b>	48
<b>M3 (M3 / mm)</b>	65

<b>M4 (M4 / mm)</b>	180
<b>N (N / mm)</b>	5
<b>P1 (P1 / mm)</b>	30
<b>P2 (P2 / mm)</b>	40
<b>P3 (P3 / mm)</b>	23
<b>P4 (P4 / mm)</b>	20.0
<b>K1 (K1 / mm)</b>	M4
<b>J1 (J1 / mm)</b>	7
<b>K2 (K2 / mm)</b>	M3
<b>J2 (J2 / mm)</b>	5.0
<b>K3 (K3 / mm)</b>	M4
<b>J3 (J3 / mm)</b>	8
<b>T1 (T1 / mm)</b>	20.0
<b>T2 (T2 / mm)</b>	0.0
<b>T3 (T3 / mm)</b>	10
<b>V (V / mm)</b>	6
<b>Y (Y)</b>	**
<b>X1 (X1 / mm)</b>	304
<b>X2 (X2 / mm)</b>	21.8
<b>W (W / mm)</b>	230
<b>Z1 (Z1 / mm)</b>	8
<b>Z2 (Z2 / mm)</b>	4
<b>U (U / mm)</b>	21.8