

Ball screw electromechanical axis - Series 5E-SBS

Product code: 5ES065BS10P1500AS1

Datasheet creation date: 07/03/2025 16:42

Check the most updated document online [click here](#)



TECHNICAL DATA

Series	5E
Profile	S = square section
Size	065
Transmission	BS = ball screw
Screw pitch	10P = 10mm
Stroke (mm)	1500
Version	A= standard axis
Type of slider	S = Standard
Number of sliders	1= 1 slider

Ball screw electromechanical axis - Series 5E-SBS

Product code: 5ES065BS10P1500AS1

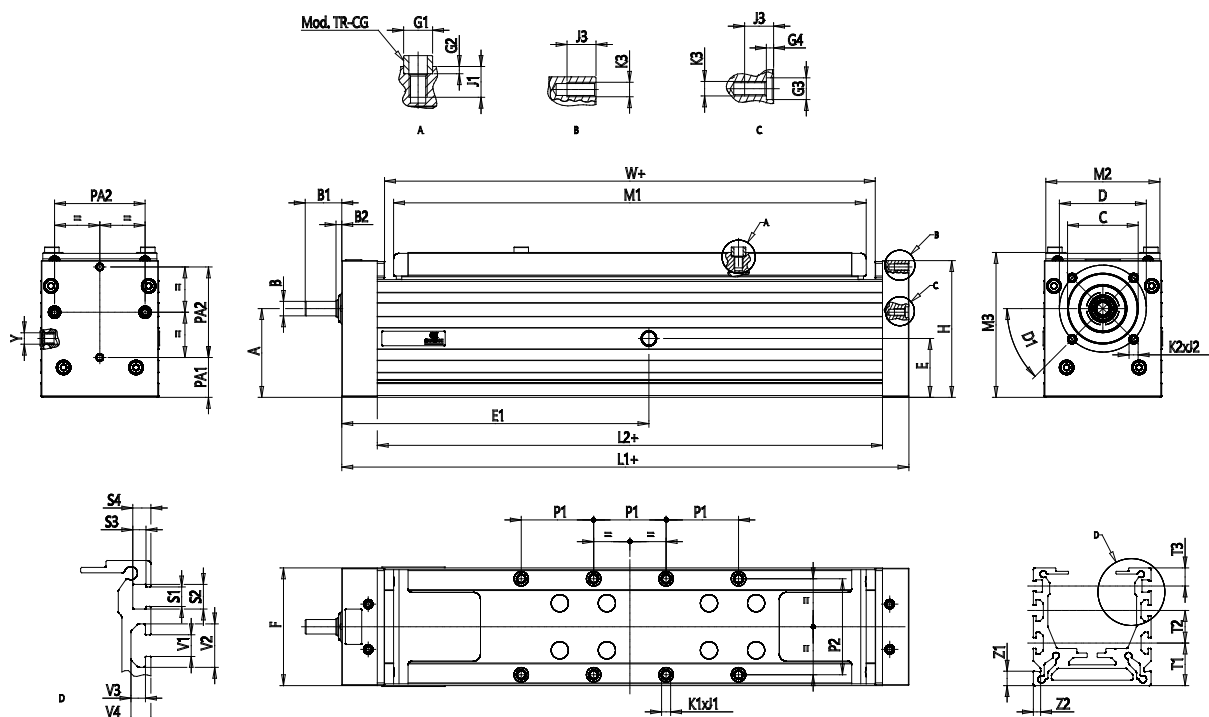

DIMENSIONS

A (mm)	49.0
B(H7) (mm)	8
B1 (mm)	20.2
B2 (mm)	3.2
C (mm)	38
D (mm)	48
D1 (°)	45
E (mm)	33
E1 (mm)	169.6
F (mm)	65
G1(H8) (mm)	8
G2 (mm)	2
G3 (mm)	6
G4 (mm)	2
H (mm)	75.5
L1 (mm)	314
L2 (mm)	279.0
M1 (mm)	261
M2 (mm)	63
M3 (mm)	80
P1 (mm)	40
P2 (mm)	53
PA1 (mm)	22

PA2 (mm)	50
K1 (mm)	M5
J1 (mm)	8
K2 (mm)	M4
J2 (mm)	6
K3 (mm)	M4
J3 (mm)	6
T1 (mm)	23.5
T2 (mm)	18
T3 (mm)	10
V (mm)	6
Y	6.3
W (mm)	271.0
Z1 (mm)	8
Z2 (mm)	4
Weight stroke zero (kg)	3.55
Stroke weight per meter (kg)	6.03