

Belt electromechanical axis - Series 5E-TBL

Product code: 5ES065TBL3800AL1

Datasheet creation date: 07/03/2025 16:41

Check the most updated document online [click here](#)



TECHNICAL DATA

SERIE (Series)	5E
PROFILO (Profile)	S = square section
TAGLIA (Size)	065
TRASMISSIONE (Transmission)	TBL = toothed belt
VERSIONE (Version)	A= standard axis
TIPOCURSORE (Type of slider)	L= long
NUMEROCURSORI (Number of sliders)	1= 1 slider
CL (CL / mm)	0
CORSA (Stroke)	3800

Belt electromechanical axis - Series 5E-TBL

Product code: 5ES065TBL3800AL1

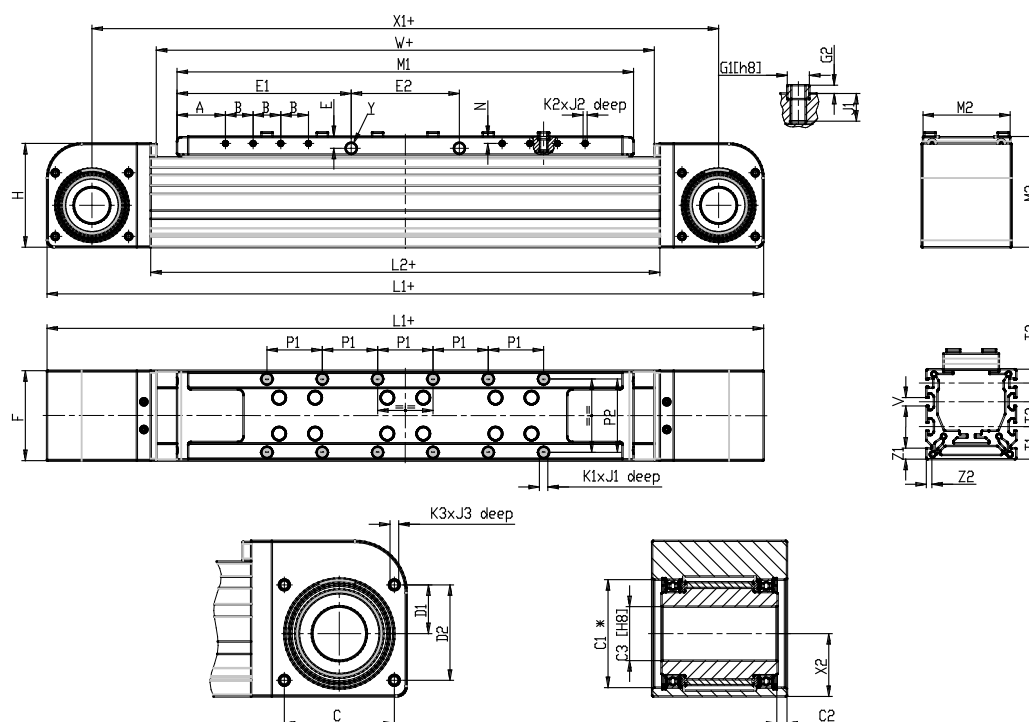

DIMENSIONS

A (A / mm)	35.0
B (B / mm)	20
C (C / mm)	53
C1 (C1 / mm)	52
C2 (C2 / mm)	5.0
C3 (C3 / mm)	26
C4 (C4 / mm)	40
C5 (C5 / mm)	56
D1 (D1 / mm)	23.5
D2 (D2 / mm)	46.0
E (E / mm)	8.5
E1 (E1 / mm)	126.0
E2 (E2 / mm)	78
F (F / mm)	65
F4 (F4 / mm)	2
G1 (Ø G1 / mm)	8
G2 (G2 / mm)	3
H (H / mm)	75
L1 (L1 / mm)	518
L2 (L2 / mm)	368
M1 (M1 / mm)	330
M2 (M2 / mm)	63
M3 (M3 / mm)	80

M4 (M4 / mm)	205
N (N / mm)	5
P1 (P1 / mm)	40
P2 (P2 / mm)	53
P3 (P3 / mm)	28
P4 (P4 / mm)	28.0
K1 (K1 / mm)	M5
J1 (J1 / mm)	8
K2 (K2 / mm)	M3
J2 (J2 / mm)	6.0
K3 (K3 / mm)	M5
J3 (J3 / mm)	10
T1 (T1 / mm)	23.5
T2 (T2 / mm)	18.0
T3 (T3 / mm)	10
V (V / mm)	6
Y (Y)	**
X1 (X1 / mm)	453
X2 (X2 / mm)	30.5
W (W / mm)	360
Z1 (Z1 / mm)	8
Z2 (Z2 / mm)	4
U (U / mm)	30.3