

Ball screw electromechanical axis - Series 5E-SBS

Product code: 5ES080BS10P1200AS1

Datasheet creation date: 07/03/2025 16:52

Check the most updated document online [click here](#)



TECHNICAL DATA

Series	5E
Profile	S = square section
Size	080
Transmission	BS = ball screw
Screw pitch	10P = 10mm
Stroke (mm)	1200
Version	A= standard axis
Type of slider	S = Standard
Number of sliders	1= 1 slider

Ball screw electromechanical axis - Series 5E-SBS

Product code: 5ES080BS10P1200AS1

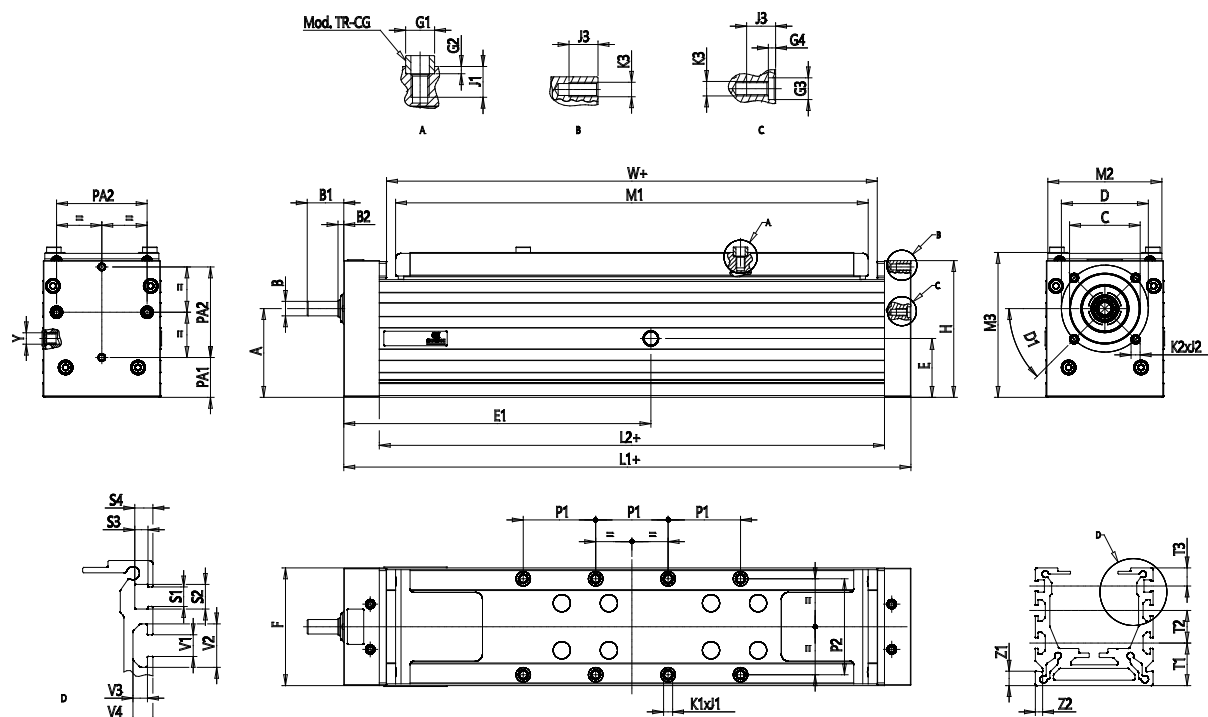

DIMENSIONS

A (mm)	62.0
B(H7) (mm)	10
B1 (mm)	21.3
B2 (mm)	0.3
C (mm)	55
D (mm)	65
D1 (°)	45
E (mm)	38
E1 (mm)	219.0
F (mm)	80
G1(H8) (mm)	10
G2 (mm)	3
G3 (mm)	8
G4 (mm)	2
H (mm)	94.5
L1 (mm)	411
L2 (mm)	368.0
M1 (mm)	350
M2 (mm)	78
M3 (mm)	100
P1 (mm)	55
P2 (mm)	64
PA1 (mm)	30

PA2 (mm)	65
K1 (mm)	M6
J1 (mm)	12
K2 (mm)	M5
J2 (mm)	10
K3 (mm)	M5
J3 (mm)	10
T1 (mm)	25.0
T2 (mm)	25
T3 (mm)	10
V (mm)	8
Y	6.3
W (mm)	360.0
Z1 (mm)	8
Z2 (mm)	4
Weight stroke zero (kg)	6.75
Stroke weight per meter (kg)	9.85