

## Belt electromechanical axis - Series 5E-TBL

Product code: 5ES080TBL0850AS1

Datasheet creation date: 07/03/2025 16:45

Check the most updated document online [click here](#)



### TECHNICAL DATA

|  |                    |
|--|--------------------|
| <b>SERIE (Series)</b>                    | 5E                 |
| <b>PROFILO (Profile)</b>                 | S = square section |
| <b>TAGLIA (Size)</b>                     | 080                |
| <b>TRASMISSIONE (Transmission)</b>       | TBL = toothed belt |
| <b>VERSIONE (Version)</b>                | A= standard axis   |
| <b>TIPOCURSORE (Type of slider)</b>      | S= standard        |
| <b>NUMEROCURSORI (Number of sliders)</b> | 1= 1 slider        |
| <b>CL (CL / mm)</b>                      | 0                  |
| <b>CORSA (Stroke)</b>                    | 850                |

## Belt electromechanical axis - Series 5E-TBL

Product code: 5ES080TBL0850AS1

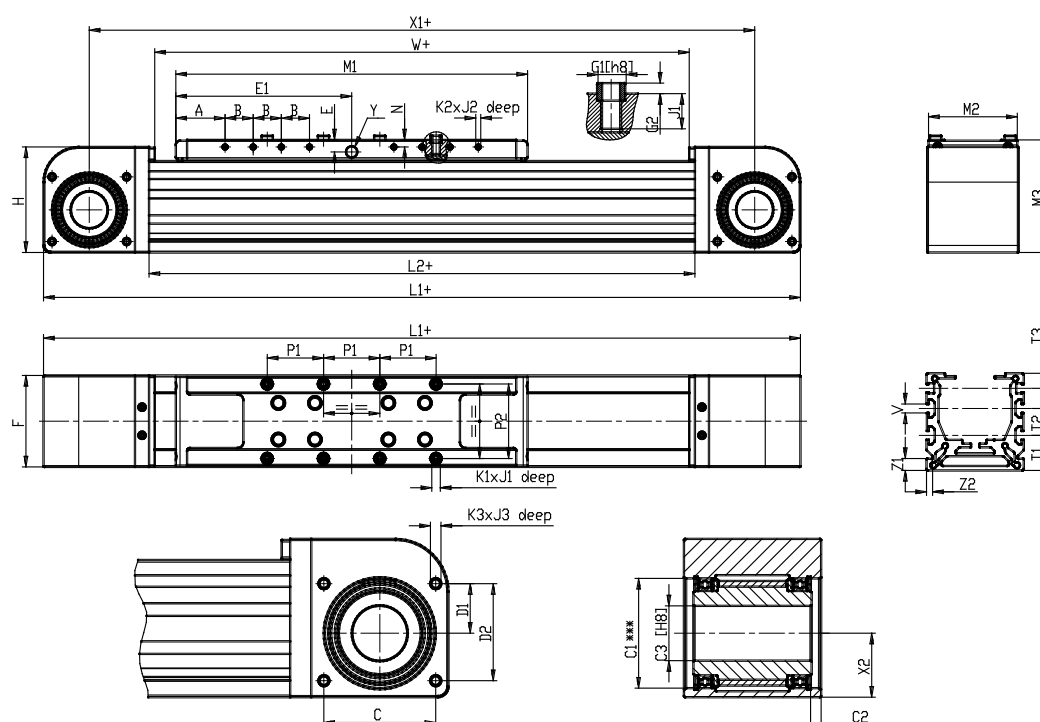

### DIMENSIONS

|                |       |
|----------------|-------|
| A (A / mm)     | 35.0  |
| B (B / mm)     | 30    |
| C (C / mm)     | 68    |
| C1 (C1 / mm)   | 68    |
| C2 (C2 / mm)   | 6.5   |
| C3 (C3 / mm)   | 38    |
| C4 (C4 / mm)   | 45    |
| C5 (C5 / mm)   | 68    |
| D1 (D1 / mm)   | 30.5  |
| D2 (D2 / mm)   | 60.5  |
| E (E / mm)     | 11.5  |
| E1 (E1 / mm)   | 165.0 |
| E2 (E2 / mm)   | 110   |
| F (F / mm)     | 80    |
| F4 (F4 / mm)   | 1     |
| G1 (Ø G1 / mm) | 10    |
| G2 (G2 / mm)   | 3     |
| H (H / mm)     | 95    |
| L1 (L1 / mm)   | 548   |
| L2 (L2 / mm)   | 368   |
| M1 (M1 / mm)   | 330   |
| M2 (M2 / mm)   | 78    |
| M3 (M3 / mm)   | 100   |

|              |      |
|--------------|------|
| M4 (M4 / mm) | 270  |
| N (N / mm)   | 8    |
| P1 (P1 / mm) | 55   |
| P2 (P2 / mm) | 64   |
| P3 (P3 / mm) | 31   |
| P4 (P4 / mm) | 33.5 |
| K1 (K1 / mm) | M6   |
| J1 (J1 / mm) | 12   |
| K2 (K2 / mm) | M4   |
| J2 (J2 / mm) | 8.5  |
| K3 (K3 / mm) | M5   |
| J3 (J3 / mm) | 10   |
| T1 (T1 / mm) | 25.0 |
| T2 (T2 / mm) | 25.0 |
| T3 (T3 / mm) | 10   |
| V (V / mm)   | 8    |
| Y (Y)        | **   |
| X1 (X1 / mm) | 468  |
| X2 (X2 / mm) | 40.5 |
| W (W / mm)   | 360  |
| Z1 (Z1 / mm) | 8    |
| Z2 (Z2 / mm) | 4    |
| U (U / mm)   | 40.5 |