

## Belt electromechanical axis - Series 5E-TBL

Product code: 5ES080TBL1800AL1

Datasheet creation date: 07/03/2025 16:47

Check the most updated document online [click here](#)



### TECHNICAL DATA

<b>SERIE (Series)</b>	5E
<b>PROFILO (Profile)</b>	S = square section
<b>TAGLIA (Size)</b>	080
<b>TRASMISSIONE (Transmission)</b>	TBL = toothed belt
<b>VERSIONE (Version)</b>	A= standard axis
<b>TIPOCURSORE (Type of slider)</b>	L= long
<b>NUMEROCURSORI (Number of sliders)</b>	1= 1 slider
<b>CL (CL / mm)</b>	0
<b>CORSA (Stroke)</b>	1800

## Belt electromechanical axis - Series 5E-TBL

Product code: 5ES080TBL1800AL1

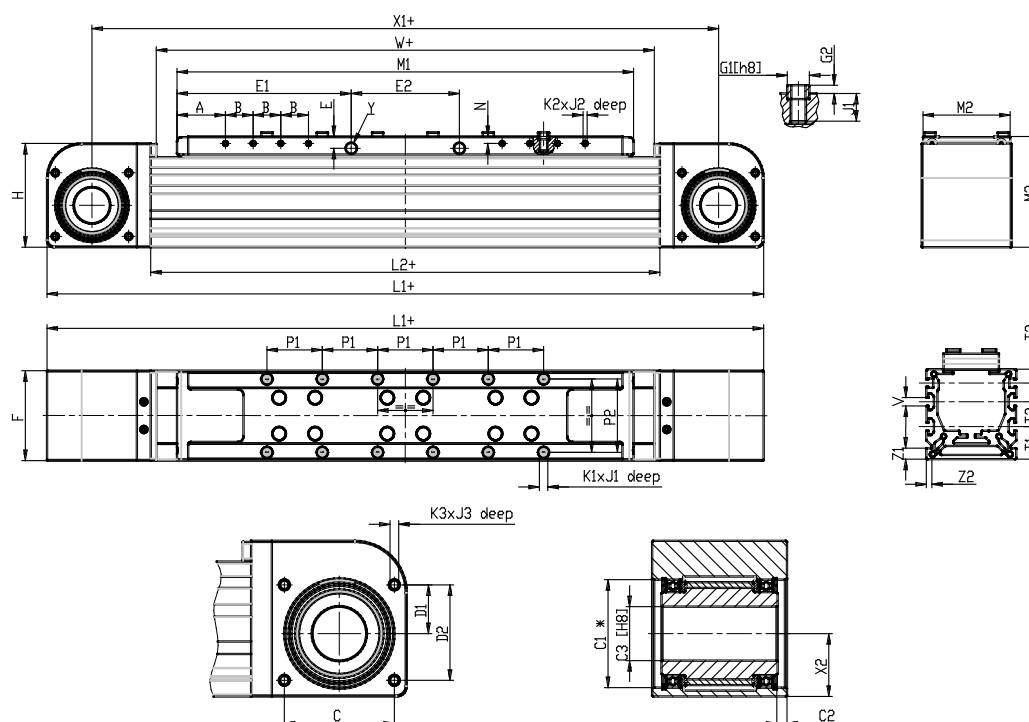

### DIMENSIONS

A (A / mm)	37.5
B (B / mm)	30
C (C / mm)	68
C1 (C1 / mm)	68
C2 (C2 / mm)	6.5
C3 (C3 / mm)	38
C4 (C4 / mm)	45
C5 (C5 / mm)	68
D1 (D1 / mm)	30.5
D2 (D2 / mm)	60.5
E (E / mm)	11.5
E1 (E1 / mm)	167.5
E2 (E2 / mm)	110
F (F / mm)	80
F4 (F4 / mm)	1
G1 (Ø G1 / mm)	10
G2 (G2 / mm)	3
H (H / mm)	95
L1 (L1 / mm)	663
L2 (L2 / mm)	483
M1 (M1 / mm)	445
M2 (M2 / mm)	78
M3 (M3 / mm)	100

M4 (M4 / mm)	270
N (N / mm)	8
P1 (P1 / mm)	55
P2 (P2 / mm)	64
P3 (P3 / mm)	31
P4 (P4 / mm)	33.5
K1 (K1 / mm)	M6
J1 (J1 / mm)	12
K2 (K2 / mm)	M4
J2 (J2 / mm)	8.5
K3 (K3 / mm)	M5
J3 (J3 / mm)	10
T1 (T1 / mm)	25.0
T2 (T2 / mm)	25.0
T3 (T3 / mm)	10
V (V / mm)	8
Y (Y)	**
X1 (X1 / mm)	583
X2 (X2 / mm)	40.5
W (W / mm)	475
Z1 (Z1 / mm)	8
Z2 (Z2 / mm)	4
U (U / mm)	40.5