

Cylinders - aluminium profile ISO 15552 (ex DIN/ISO 6431 / VDMA 24562) - Series 61

Product code: 61M2P050A0770

Datasheet creation date: 09/03/2025 11:02

Check the most updated document online [click here](#)



TECHNICAL DATA

SERIE (Series / mm)	61
PHY (Diameter / mm)	50
VERSION (Version)	M = magnetic standard
FUNZ (Operation)	2=double acting (front and rear cushions)
MAT (Materials)	P = standard: AL end-blocks and piston, rolled stainless steel AISI 420B rod, anodized AL profile tube, zinc-plated steel tie-rods and tie-rod nuts, PU seals
TYP (Construction)	A = standard with lock nut for rod
HUBT (Stroke type)	variable
HUB (Stroke / mm)	770
ES (execution)	-
LSTELO (extended piston / mm)	0

Cylinders - aluminium profile ISO 15552 (ex DIN/ISO 6431 / VDMA 24562) - Series 61

Product code: 61M2P050A0770

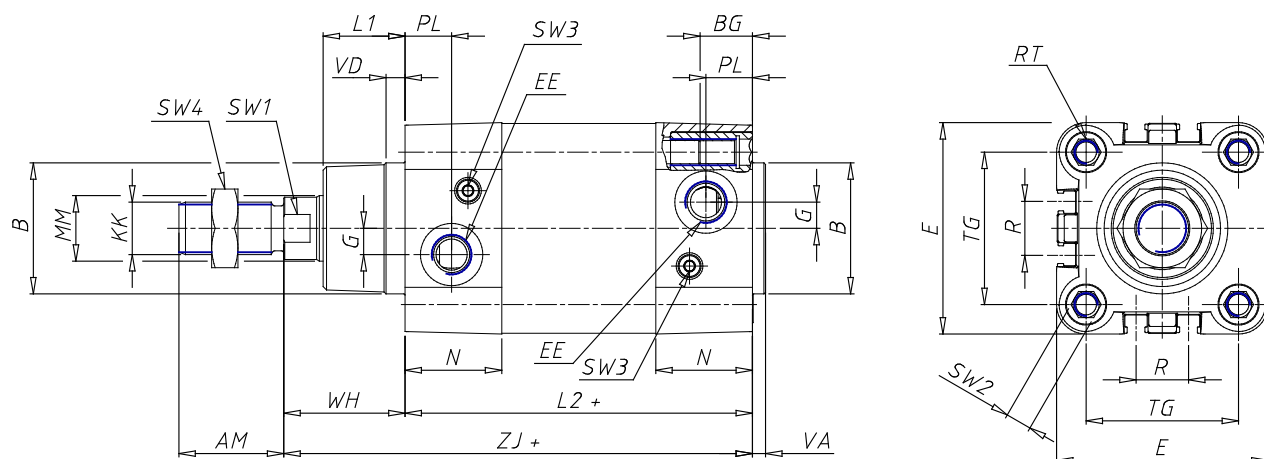

DIMENSIONS

MM (MM / mm)	20
KK (KK)	M16x1,5
B (B d11 / mm)	40
PL (PL / mm)	15
L1 (L1 / mm)	25
AM (AM / mm)	32
VA (VA / mm)	4
EE (EE)	G1/4
WH (WH / mm)	37
L2 (L2 / mm)	106.0
ZM (ZM / mm)	-
ZJ (ZJ / mm)	143
VD (VD / mm)	6
N (N / mm)	29.5
BG (BG / mm)	16.0
RT (RT)	M8
G (G / mm)	8.0
TG (TG / mm)	46.5
R (R / mm)	16.0
E (E / mm)	64.5
SW1 (SW1 / mm)	17
SW2 (SW2 / mm)	8
SW3 (SW3 / mm)	3

SW4 (SW4 / mm)	24
HUBA (Cushion stroke front spring)	15
HUBP (Cushion stroke rear spring)	14
L3 (L3 / mm)	225.0
L4 (L4 / mm)	15
L5 (L5 / mm)	16
L6 (L6 / mm)	29.5
L7 (L7 / mm)	48.0
L8 (L8 / mm)	60
L9 (L9 / mm)	106.0
L10 (/ mm)	200.0
D (ø D / mm)	20
D1 (ø D1 d11 / mm)	40.0
D2 (ø D2 / mm)	50
D3 (ø D3 f6 / mm)	35
A (± 0.15 / mm)	46.5
GX (GX)	G1/8
H (H / mm)	36.0
H1 (H1 / mm)	64.0
M (M)	M8
Z (Z)	M8 x 30