

3/2-way solenoid valve - Mod. 638M/63CM

Product code: 638M-101-A62

Datasheet creation date: 10/03/2025 11:26

Check the most updated document online [click here](#)



TECHNICAL DATA

Cod.	638M-101-A6
Voltage	2 = 12 V DC - 10 W
Version	= Standard

3/2-way solenoid valve - Mod. 638M/63CM

Product code: 638M-101-A62

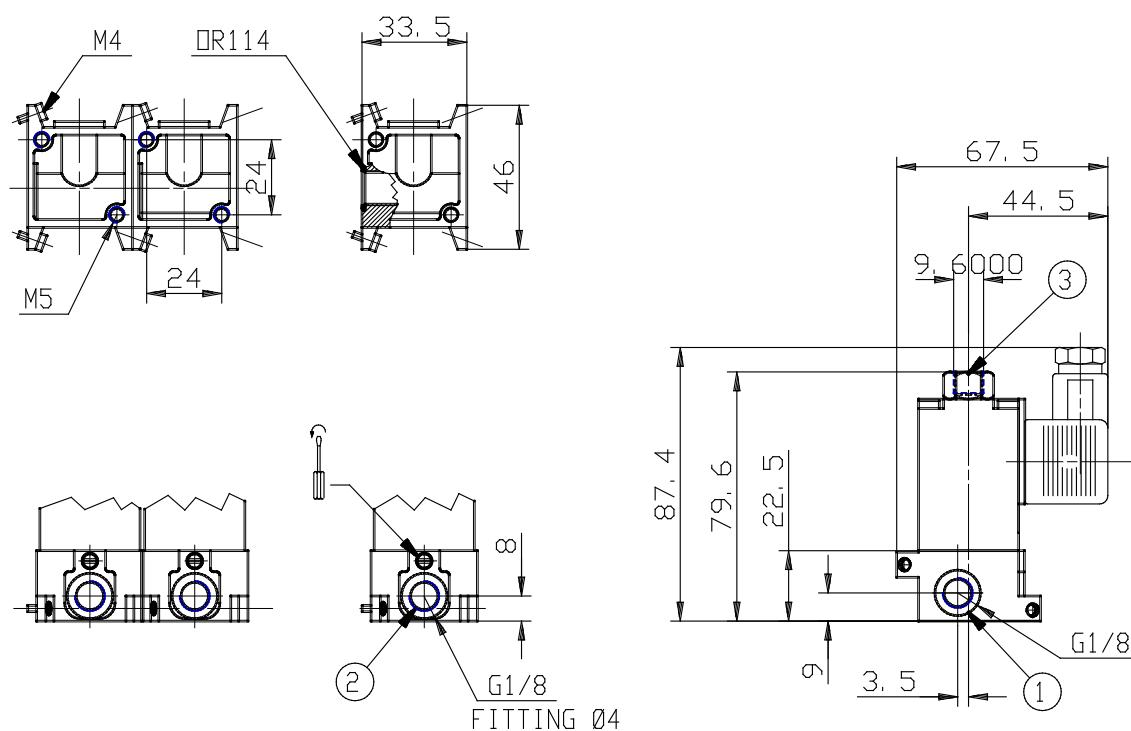

DIMENSIONS

Inlet / outlet	G1/8 / G1/8
Function	3/2 N.C.
Orifice (Ø mm)	2
Qn (NI/mm)	120
Pressure min-max (bar)	0÷10