

End Lock cylinders - Series 63

Product code: 63MP2C032A0040DL

Datasheet creation date: 09/03/2025 12:24

Check the most updated document online [click here](#)



TECHNICAL DATA

Series	63
Version	M = standard, magnetic
Construction	P= profile tube
Operation	2 = double effect
Cushioning	C = cushioning on both sides
Bore (mm)	32
Construction type	A = standard with rod nut
Stroke type	variable
Stroke (mm)	40
Stroke2 (mm)	0
Rod length (mm)	0
Rod length 2 (mm)	0
Lock type	DL = Double lock
Temperature range	= standard (-20°/+80°C)
Resistance to corrosion	= Standard
Manual unlock type	= manual with M3 screw (not included)
Variants	= standard (male rod)
Certifications	= Standard

End Lock cylinders - Series 63

Product code: 63MP2C032A0040DL

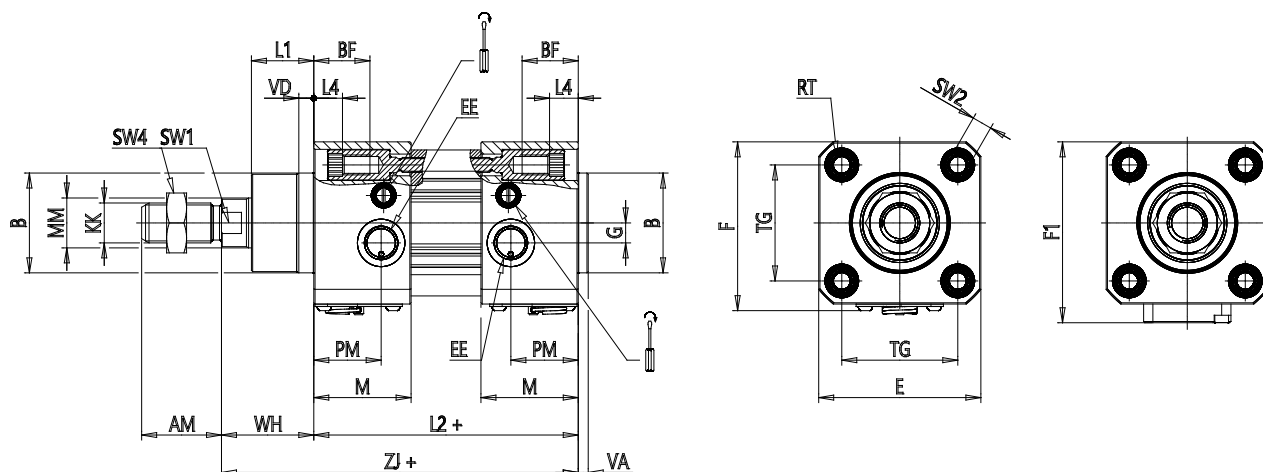

DIMENSIONS

MM (mm)	12
KK	M10x1,25
B (mm)	30
PL (mm)	18.5
PM (mm)	18
L1 (mm)	18
AM (mm)	22
VA (mm)	4
EE	G1/8
WH (mm)	26
L2 (mm)	94
L3 (mm)	5.5
L4 (mm)	11.5
ZJ (mm)	120
VD (mm)	5
N (mm)	27.0
BG (mm)	16.0
M (mm)	34
BF (mm)	22.0
RT (mm)	M6
G (mm)	5.0
TG (mm)	32.5
R (mm)	13

E (mm)	47
F (mm)	49.7
F1 (mm)	57.0
SW1 (mm)	10
SW2 (mm)	6
SW3 (mm)	2
SW4 (mm)	17
Front cushioning (mm)	17
Rear cushioning (mm)	17.0