

## End Lock cylinders - Series 63

Product code: 63MP2C032A0160DL

Datasheet creation date: 09/03/2025 12:25

Check the most updated document online [click here](#)



### TECHNICAL DATA

<b>Series</b>	63
<b>Version</b>	M = standard, magnetic
<b>Construction</b>	P= profile tube
<b>Operation</b>	2 = double effect
<b>Cushioning</b>	C = cushioning on both sides
<b>Bore (mm)</b>	32
<b>Construction type</b>	A = standard with rod nut
<b>Stroke type</b>	standard
<b>Stroke (mm)</b>	160
<b>Stroke2 (mm)</b>	0
<b>Rod length (mm)</b>	0
<b>Rod length 2 (mm)</b>	0
<b>Lock type</b>	DL = Double lock
<b>Temperature range</b>	= standard (-20°/+80°C)
<b>Resistance to corrosion</b>	= Standard
<b>Manual unlock type</b>	= manual with M3 screw (not included)
<b>Variants</b>	= standard (male rod)
<b>Certifications</b>	= Standard

## End Lock cylinders - Series 63

Product code: 63MP2C032A0160DL

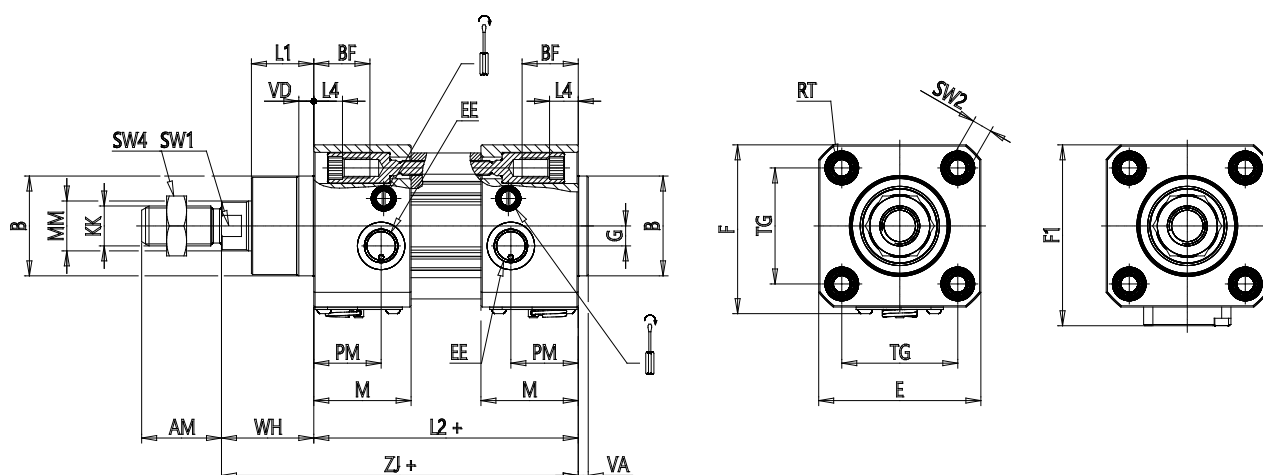

### DIMENSIONS

MM (mm)	12
KK	M10x1,25
B (mm)	30
PL (mm)	18.5
PM (mm)	18
L1 (mm)	18
AM (mm)	22
VA (mm)	4
EE	G1/8
WH (mm)	26
L2 (mm)	94
L3 (mm)	5.5
L4 (mm)	11.5
ZJ (mm)	120
VD (mm)	5
N (mm)	27.0
BG (mm)	16.0
M (mm)	34
BF (mm)	22.0
RT (mm)	M6
G (mm)	5.0
TG (mm)	32.5
R (mm)	13

E (mm)	47
F (mm)	49.7
F1 (mm)	57.0
SW1 (mm)	10
SW2 (mm)	6
SW3 (mm)	2
SW4 (mm)	17
Front cushioning (mm)	17
Rear cushioning (mm)	17.0