

Cylinders ISO 15552 - Series 63

Product code: 63MP2C032RL0650

Datasheet creation date: 09/03/2025 13:22

Check the most updated document online [click here](#)



TECHNICAL DATA

Series	63
Version	M = standard, magnetic
Costrction	P = profile tube
Operation	2 = double effect
Cushioning	C = cushioning on both sides
Bore (mm)	32
Construction	RL = cylinder with rod lock
Stroke type	- = variable
X1 (stroke cylinders) it has to be smaller of X2 (mm)	650
X2 (stroke cylinders) it has to be greater of X1 (mm)	0
Temperature Range	= standard (-20°/+80°C)
Resistence to corrosion	= standard
Rod variants	= standard (male thread rod)
End caps variants	= standard
Variants of rod seals	= standard
Rod seal protection variants	= standard
Bellow protection variants	= standard
Rod length (mm)	0
Other	= standard
Certifications	= standard

Cylinders ISO 15552 - Series 63

Product code: 63MP2C032RL0650

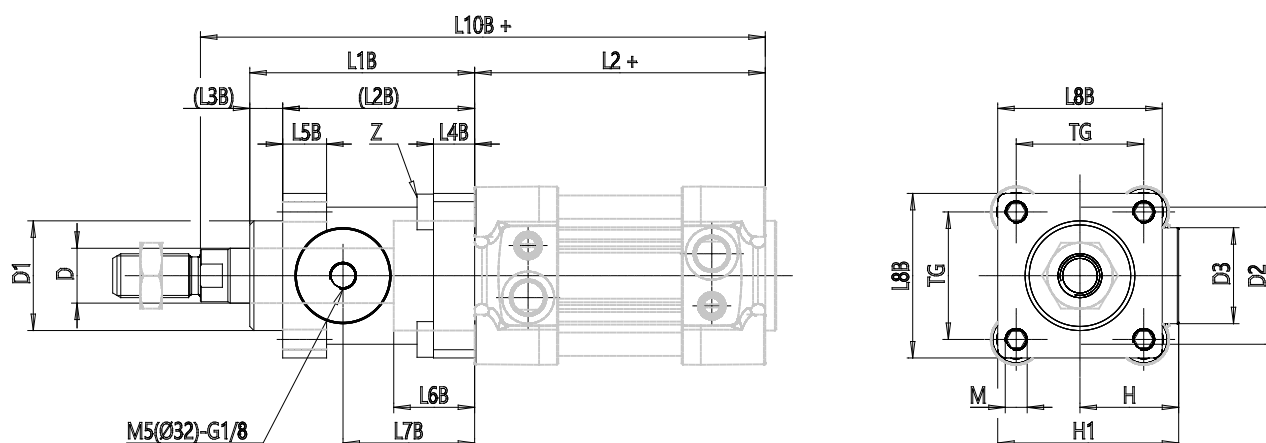

DIMENSIONS

MM (mm)	12
KK	M10x1,25
B (mm)	30
PL (mm)	18.5
L1 (mm)	18
AM (mm)	22
VA (mm)	4
EE	G1/8
WH (mm)	66.000
L2 (mm)	94.0
L3 (mm)	5.5
L4 (mm)	18.5
ZM (mm)	-
ZJ (mm)	120
VD (mm)	5
N (mm)	27.0
BG (mm)	16.0
RT	M6
G (mm)	5.0
TG (mm)	32.5
E (mm)	47.0
SW1 (mm)	10
SW2 (mm)	6

SW3 (mm)	2
SW4 (mm)	17
Cushion stroke (mm)	19
DE (mm)	61
P (mm)	25
R	M5
LB (mm)	36.0
D1 (mm)	30.5
D2 (mm)	35
D3 (mm)	25
A (mm)	32.5
G2	M5
H (mm)	25.5
H1 (mm)	46.5
L1B (mm)	58
L2B (mm)	48
L3B (mm)	10
L4B (mm)	8
L5B (mm)	13
L6B (mm)	20.5
L7B (mm)	34.0
L8B (mm)	45
L9B (mm)	94