

Cylinders ISO 1552 - Series 63

Product code: 63MP2C040A1600

Datasheet creation date: 09/03/2025 13:39

Check the most updated document online [click here](#)



TECHNICAL DATA

Series	63
Version	M = standard, magnetic
Costrction	P = profile tube
Operation	2 = double effect
Cushioning	C = cushioning on both sides
Bore (mm)	40
Construction	A = standard with lock nut for rod
Stroke type	- = variable
X1 (stroke cylinders) it has to be smaller of X2 (mm)	1600
X2 (stroke cylinders) it has to be greater of X1 (mm)	0
Temperature Range	= standard (-20°/+80°C)
Resistence to corrosion	= standard
Rod variants	= standard (male thread rod)
End caps variants	= standard
Variants of rod seals	= standard
Rod seal protection variants	= standard
Bellow protection variants	= standard
Rod length (mm)	0
Other	= standard
Certifications	= standard

Cylinders ISO 1552 - Series 63

Product code: 63MP2C040A1600

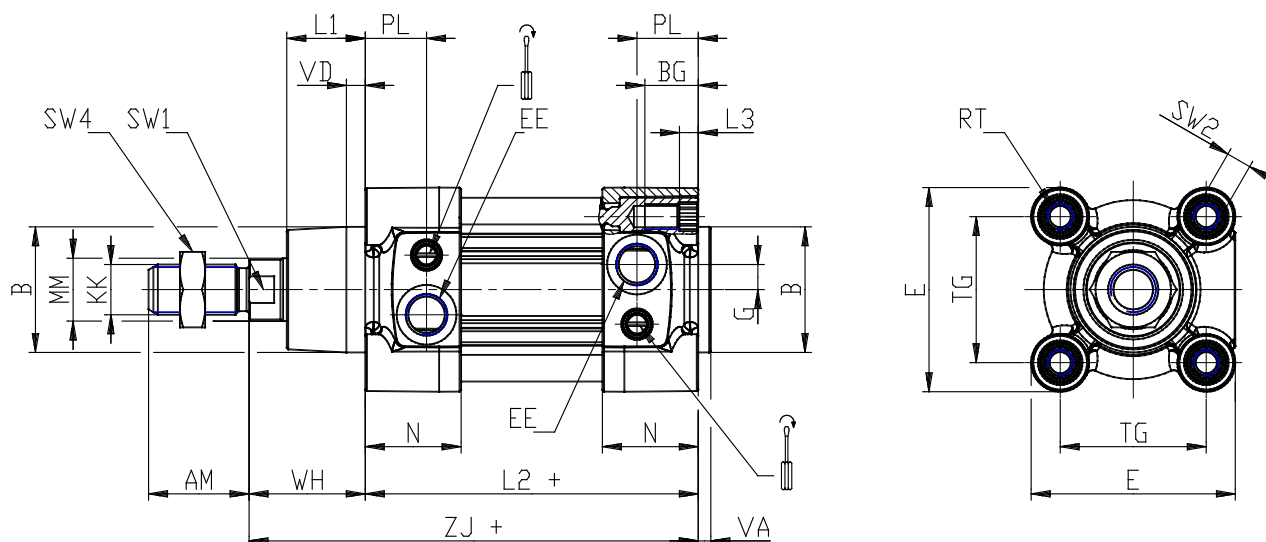

DIMENSIONS

MM (mm)	16
KK	M12x1,25
B (mm)	35
PL (mm)	19.0
L1 (mm)	21
AM (mm)	24
VA (mm)	4
EE	G1/4
WH (mm)	30.000
L2 (mm)	105.0
L3 (mm)	5.5
L4 (mm)	23.0
ZM (mm)	-
ZJ (mm)	135
VD (mm)	5
N (mm)	30.0
BG (mm)	16.0
RT	M6
G (mm)	5.0
TG (mm)	38.0
E (mm)	55.0
SW1 (mm)	13
SW2 (mm)	6

SW3 (mm)	2
SW4 (mm)	19
Cushion stroke (mm)	22
DE (mm)	61
P (mm)	26
R	M5
LB (mm)	36.6
D1 (mm)	35.0
D2 (mm)	40
D3 (mm)	28
A (mm)	38.0
G2	G1/8
H (mm)	30.0
H1 (mm)	53.0
L1B (mm)	65
L2B (mm)	55
L3B (mm)	10
L4B (mm)	8
L5B (mm)	13
L6B (mm)	22.5
L7B (mm)	38.0
L8B (mm)	50
L9B (mm)	105