

End Lock cylinders - Series 63

Product code: 63MP2C040F0950BLT

Datasheet creation date: 09/03/2025 12:29

Check the most updated document online [click here](#)



TECHNICAL DATA

Series	63
Version	M = standard, magnetic
Construction	P= profile tube
Operation	2 = double effect
Cushioning	C = cushioning on both sides
Bore (mm)	40
Construction type	F = cylinder with intermediate hinge
Stroke type	variable
Stroke (mm)	950
Stroke2 (mm)	0
Rod length (mm)	0
Rod length 2 (mm)	0
Lock type	BL = Rear lock
Temperature range	= standard (-20°/+80°C)
Resistance to corrosion	= Standard
Manual unlock type	T = manual integrated with release pin and protective cover
Variants	= standard (male rod)
Certifications	= Standard

End Lock cylinders - Series 63

Product code: 63MP2C040F0950BLT

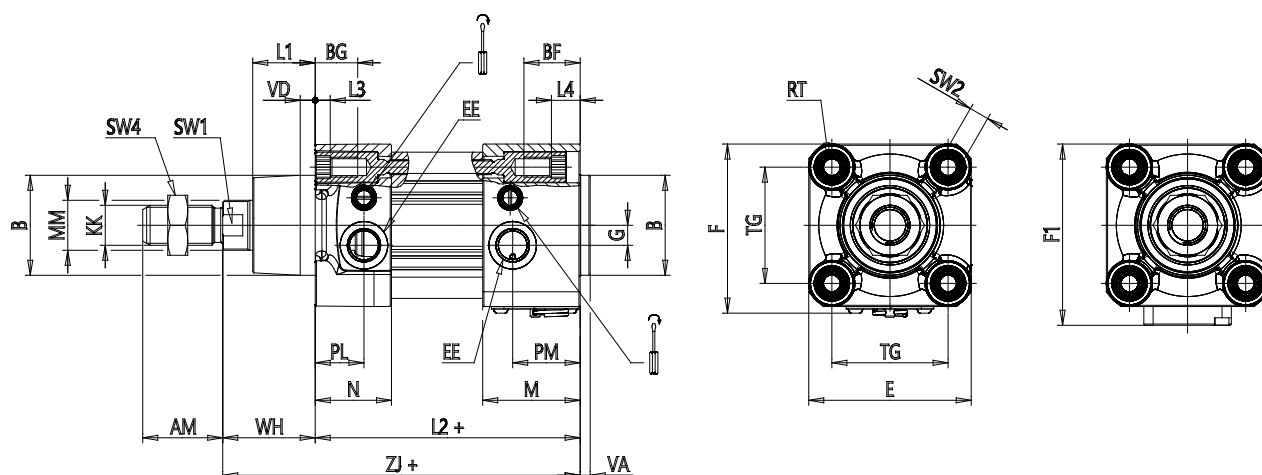

DIMENSIONS

MM (mm)	16
KK	M12x1,25
B (mm)	35
PL (mm)	19.0
PM (mm)	24
L1 (mm)	21
AM (mm)	24
VA (mm)	4
EE	G1/4
WH (mm)	30
L2 (mm)	105
L3 (mm)	5.5
L4 (mm)	15.0
ZJ (mm)	135
VD (mm)	5
N (mm)	30.0
BG (mm)	16.0
M (mm)	40
BF (mm)	25.5
RT (mm)	M6
G (mm)	5.0
TG (mm)	38.0
R (mm)	13.5

E (mm)	55
F (mm)	57.7
F1 (mm)	64.5
SW1 (mm)	13
SW2 (mm)	6
SW3 (mm)	2
SW4 (mm)	19
Front cushioning (mm)	17
Rear cushioning (mm)	17.0