

End Lock cylinders - Series 63

Product code: 63MP2C050A0300DL

Datasheet creation date: 09/03/2025 12:31

Check the most updated document online [click here](#)



TECHNICAL DATA

Series	63
Version	M = standard, magnetic
Construction	P= profile tube
Operation	2 = double effect
Cushioning	C = cushioning on both sides
Bore (mm)	50
Construction type	A = standard with rod nut
Stroke type	standard
Stroke (mm)	300
Stroke2 (mm)	0
Rod length (mm)	0
Rod length 2 (mm)	0
Lock type	DL = Double lock
Temperature range	= standard (-20°/+80°C)
Resistance to corrosion	= Standard
Manual unlock type	= manual with M3 screw (not included)
Variants	= standard (male rod)
Certifications	= Standard

End Lock cylinders - Series 63

Product code: 63MP2C050A0300DL

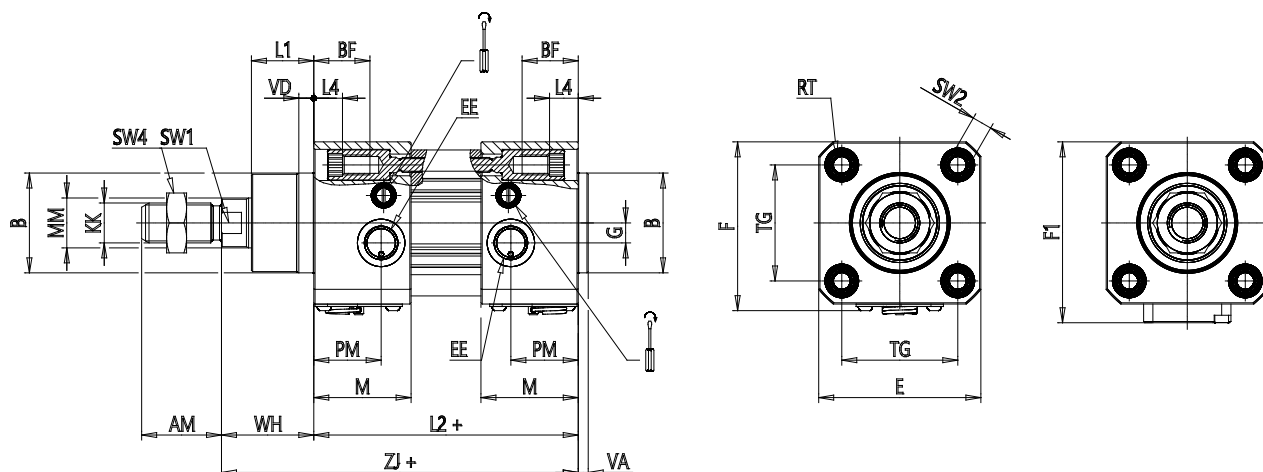

DIMENSIONS

MM (mm)	20
KK	M16x1,5
B (mm)	40
PL (mm)	19.5
PM (mm)	27
L1 (mm)	25
AM (mm)	32
VA (mm)	4
EE	G1/4
WH (mm)	37
L2 (mm)	106
L3 (mm)	6.0
L4 (mm)	11.5
ZJ (mm)	143
VD (mm)	6
N (mm)	30.5
BG (mm)	16.0
M (mm)	39
BF (mm)	21.5
RT (mm)	M8
G (mm)	8.0
TG (mm)	46.5
R (mm)	16

E (mm)	65
F (mm)	67.7
F1 (mm)	72.5
SW1 (mm)	17
SW2 (mm)	8
SW3 (mm)	3
SW4 (mm)	24
Front cushioning (mm)	19
Rear cushioning (mm)	14.5