

## End Lock cylinders - Series 63

Product code: 63MP2C063A0200DL

Datasheet creation date: 09/03/2025 12:35

Check the most updated document online [click here](#)



### TECHNICAL DATA

<b>Series</b>	63
<b>Version</b>	M = standard, magnetic
<b>Construction</b>	P= profile tube
<b>Operation</b>	2 = double effect
<b>Cushioning</b>	C = cushioning on both sides
<b>Bore (mm)</b>	63
<b>Construction type</b>	A = standard with rod nut
<b>Stroke type</b>	standard
<b>Stroke (mm)</b>	200
<b>Stroke2 (mm)</b>	0
<b>Rod length (mm)</b>	0
<b>Rod length 2 (mm)</b>	0
<b>Lock type</b>	DL = Double lock
<b>Temperature range</b>	= standard (-20°/+80°C)
<b>Resistance to corrosion</b>	= Standard
<b>Manual unlock type</b>	= manual with M3 screw (not included)
<b>Variants</b>	= standard (male rod)
<b>Certifications</b>	= Standard

## End Lock cylinders - Series 63

Product code: 63MP2C063A0200DL

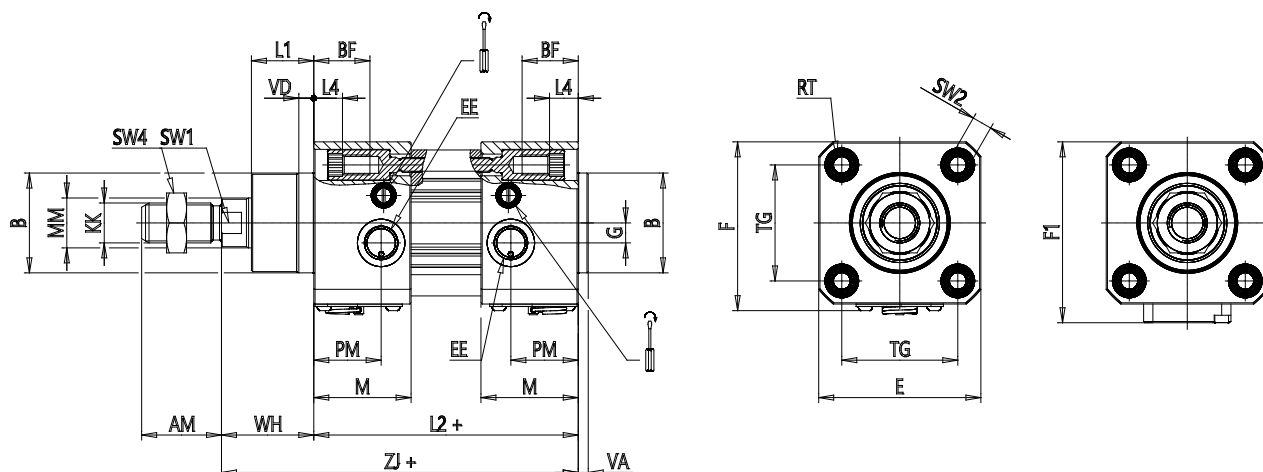

### DIMENSIONS

MM (mm)	20
KK	M16x1,5
B (mm)	45
PL (mm)	24.0
PM (mm)	27
L1 (mm)	26
AM (mm)	32
VA (mm)	4
EE	G3/8
WH (mm)	37
L2 (mm)	121
L3 (mm)	6.0
L4 (mm)	12.5
ZJ (mm)	158
VD (mm)	6
N (mm)	37.5
BG (mm)	16.0
M (mm)	44
BF (mm)	22.5
RT (mm)	M8
G (mm)	8.0
TG (mm)	56.5
R (mm)	28

E (mm)	75
F (mm)	77.5
F1 (mm)	82.5
SW1 (mm)	17
SW2 (mm)	8
SW3 (mm)	3
SW4 (mm)	24
Front cushioning (mm)	19
Rear cushioning (mm)	19.5