

Cylinders ISO 15552 - Series 63

Product code: 63MP2C063A2010R

Datasheet creation date: 09/03/2025 14:12

Check the most updated document online [click here](#)



TECHNICAL DATA

Series	63
Version	M = standard, magnetic
Costrction	P = profile tube
Operation	2 = double effect
Cushioning	C = cushioning on both sides
Bore (mm)	63
Construction	A = standard with lock nut for rod
Stroke type	- = variable
X1 (stroke cylinders) it has to be smaller of X2 (mm)	2010
X2 (stroke cylinders) it has to be greater of X1 (mm)	0
Temperature Range	= standard (-20°/+80°C)
Resistence to corrosion	= standard
Rod variants	= standard (male thread rod)
End caps variants	= standard
Variants of rod seals	R = NBR rod seal
Rod seal protection variants	= standard
Bellow protection variants	= standard
Rod length (mm)	0
Other	= standard
Certifications	= standard

Cylinders ISO 1552 - Series 63

Product code: 63MP2C063A2010R

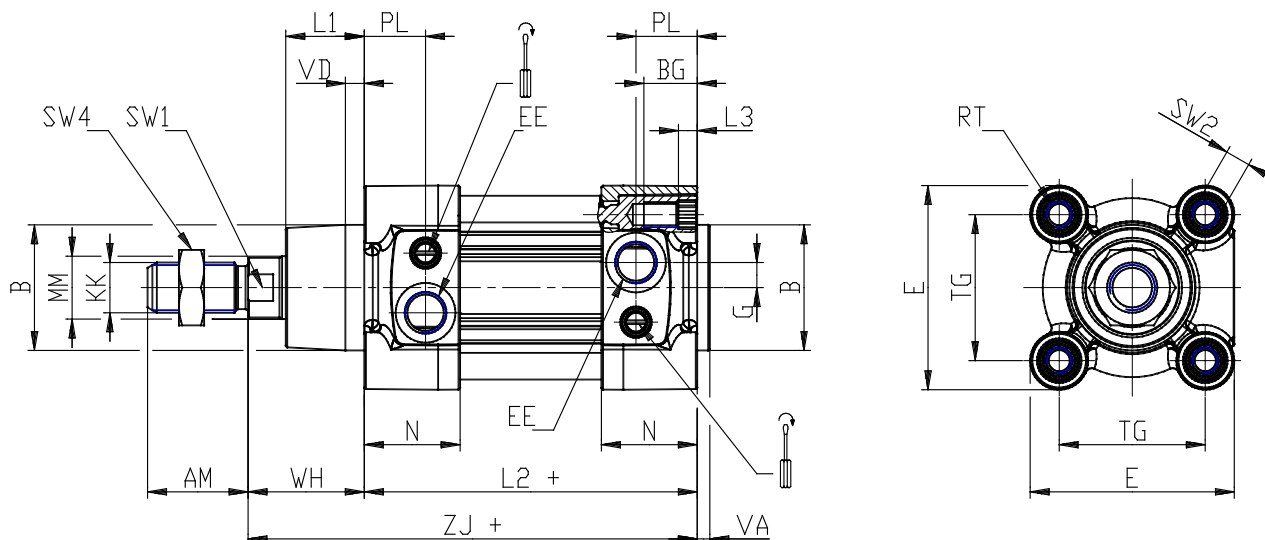

DIMENSIONS

MM (mm)	20
KK	M16x1,5
B (mm)	45
PL (mm)	24.0
L1 (mm)	26
AM (mm)	32
VA (mm)	4
EE	G3/8
WH (mm)	37.000
L2 (mm)	121.0
L3 (mm)	6.0
L4 (mm)	27.0
ZM (mm)	-
ZJ (mm)	158
VD (mm)	6
N (mm)	37.5
BG (mm)	16.0
RT	M8
G (mm)	8.0
TG (mm)	56.5
E (mm)	75.0
SW1 (mm)	17
SW2 (mm)	8

SW3 (mm)	3
SW4 (mm)	24
Cushion stroke (mm)	22
DE (mm)	61
P (mm)	16
R	M5
LB (mm)	20.5
D1 (mm)	45.0
D2 (mm)	60
D3 (mm)	38
A (mm)	56.5
G2	G1/8
H (mm)	40.0
H1 (mm)	75.0
L1B (mm)	82
L2B (mm)	70
L3B (mm)	12
L4B (mm)	15
L5B (mm)	16
L6B (mm)	29.5
L7B (mm)	49.5
L8B (mm)	70
L9B (mm)	121