

End Lock cylinders - Series 63

Product code: 63MP2C080A0400DL

Datasheet creation date: 09/03/2025 12:38

Check the most updated document online [click here](#)



TECHNICAL DATA

Series	63
Version	M = standard, magnetic
Construction	P= profile tube
Operation	2 = double effect
Cushioning	C = cushioning on both sides
Bore (mm)	80
Construction type	A = standard with rod nut
Stroke type	standard
Stroke (mm)	400
Stroke2 (mm)	0
Rod length (mm)	0
Rod length 2 (mm)	0
Lock type	DL = Double lock
Temperature range	= standard (-20°/+80°C)
Resistance to corrosion	= Standard
Manual unlock type	= manual with M3 screw (not included)
Variants	= standard (male rod)
Certifications	= Standard

End Lock cylinders - Series 63

Product code: 63MP2C080A0400DL

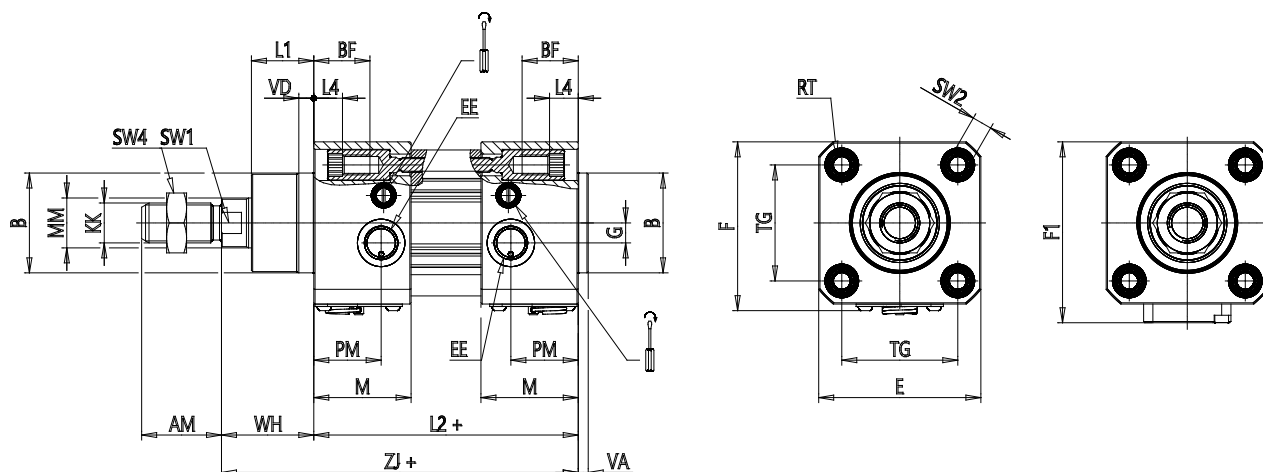

DIMENSIONS

MM (mm)	25
KK	M20x1,5
B (mm)	45
PL (mm)	23.5
PM (mm)	32
L1 (mm)	30
AM (mm)	40
VA (mm)	4
EE	G3/8
WH (mm)	46
L2 (mm)	128
L3 (mm)	0.0
L4 (mm)	6.0
ZJ (mm)	174
VD (mm)	7
N (mm)	37.0
BG (mm)	19.0
M (mm)	46
BF (mm)	25.0
RT (mm)	M10
G (mm)	8.0
TG (mm)	72.0
R (mm)	30

E (mm)	93
F (mm)	95.7
F1 (mm)	99.5
SW1 (mm)	22
SW2 (mm)	6
SW3 (mm)	5
SW4 (mm)	30
Front cushioning (mm)	21
Rear cushioning (mm)	17.0