

Cylinders ISO 15552 - Series 63

Product code: 63MP2C080RL0500

Datasheet creation date: 09/03/2025 14:24

Check the most updated document online [click here](#)



TECHNICAL DATA

Series	63
Version	M = standard, magnetic
Costrction	P = profile tube
Operation	2 = double effect
Cushioning	C = cushioning on both sides
Bore (mm)	80
Construction	RL = cylinder with rod lock
Stroke type	= standard
X1 (stroke cylinders) it has to be smaller of X2 (mm)	500
X2 (stroke cylinders) it has to be greater of X1 (mm)	0
Temperature Range	= standard (-20°/+80°C)
Resistence to corrosion	= standard
Rod variants	= standard (male thread rod)
End caps variants	= standard
Variants of rod seals	= standard
Rod seal protection variants	= standard
Bellow protection variants	= standard
Rod length (mm)	0
Other	= standard
Certifications	= standard

Cylinders ISO 15552 - Series 63

Product code: 63MP2C080RL0500

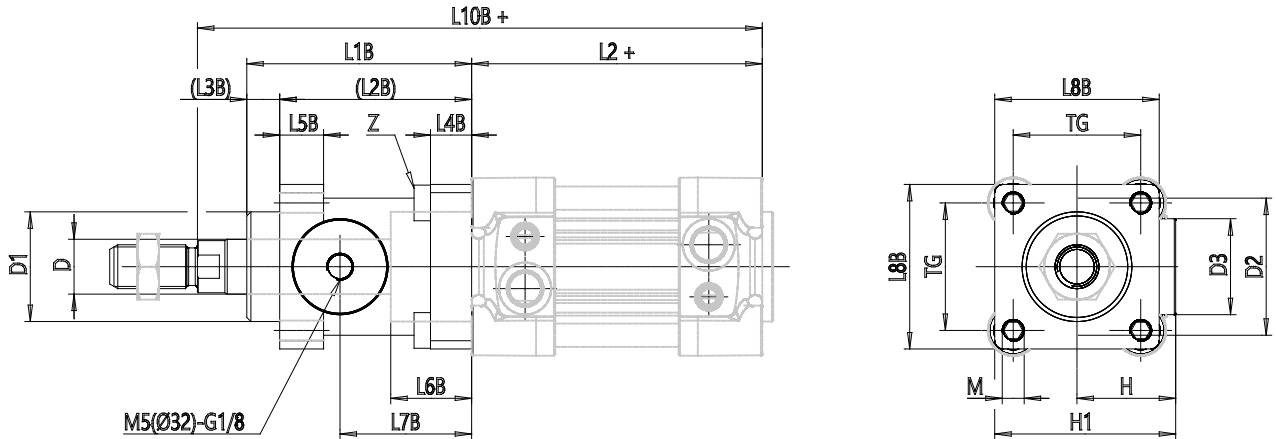

DIMENSIONS

MM (mm)	25
KK	M20x1,5
B (mm)	45
PL (mm)	23.5
L1 (mm)	30
AM (mm)	40
VA (mm)	4
EE	G3/8
WH (mm)	126.000
L2 (mm)	128.0
L3 (mm)	0.0
L4 (mm)	27.0
ZM (mm)	-
ZJ (mm)	174
VD (mm)	7
N (mm)	37.0
BG (mm)	19.0
RT	M10
G (mm)	8.0
TG (mm)	72.0
E (mm)	93.0
SW1 (mm)	22
SW2 (mm)	6

SW3 (mm)	5
SW4 (mm)	30
Cushion stroke (mm)	25
DE (mm)	83
P (mm)	12
R	G1/8
LB (mm)	17.5
D1 (mm)	45.0
D2 (mm)	80
D3 (mm)	48
A (mm)	72.0
G2	G1/8
H (mm)	50.0
H1 (mm)	95.0
L1B (mm)	110
L2B (mm)	90
L3B (mm)	20
L4B (mm)	18
L5B (mm)	20
L6B (mm)	35.0
L7B (mm)	61.0
L8B (mm)	90
L9B (mm)	128