

Cylinders ISO 1552 - Series 63

Product code: 63MP2C100A0320B

Datasheet creation date: 09/03/2025 12:47

Check the most updated document online [click here](#)



TECHNICAL DATA

Series	63
Version	M = standard, magnetic
Costrction	P = profile tube
Operation	2 = double effect
Cushioning	C = cushioning on both sides
Bore (mm)	100
Construction	A = standard with lock nut for rod
Stroke type	= standard
X1 (stroke cylinders) it has to be smaller of X2 (mm)	320
X2 (stroke cylinders) it has to be greater of X1 (mm)	0
Temperature Range	= standard (-20°/+80°C)
Resistence to corrosion	= standard
Rod variants	= standard (male thread rod)
End caps variants	= standard
Variants of rod seals	= standard
Rod seal protection variants	= standard
Bellow protection variants	B = cylinder with NBR bellow rod protection
Rod length (mm)	0
Other	= standard
Certifications	= standard

Cylinders ISO 1552 - Series 63

Product code: 63MP2C100A0320B

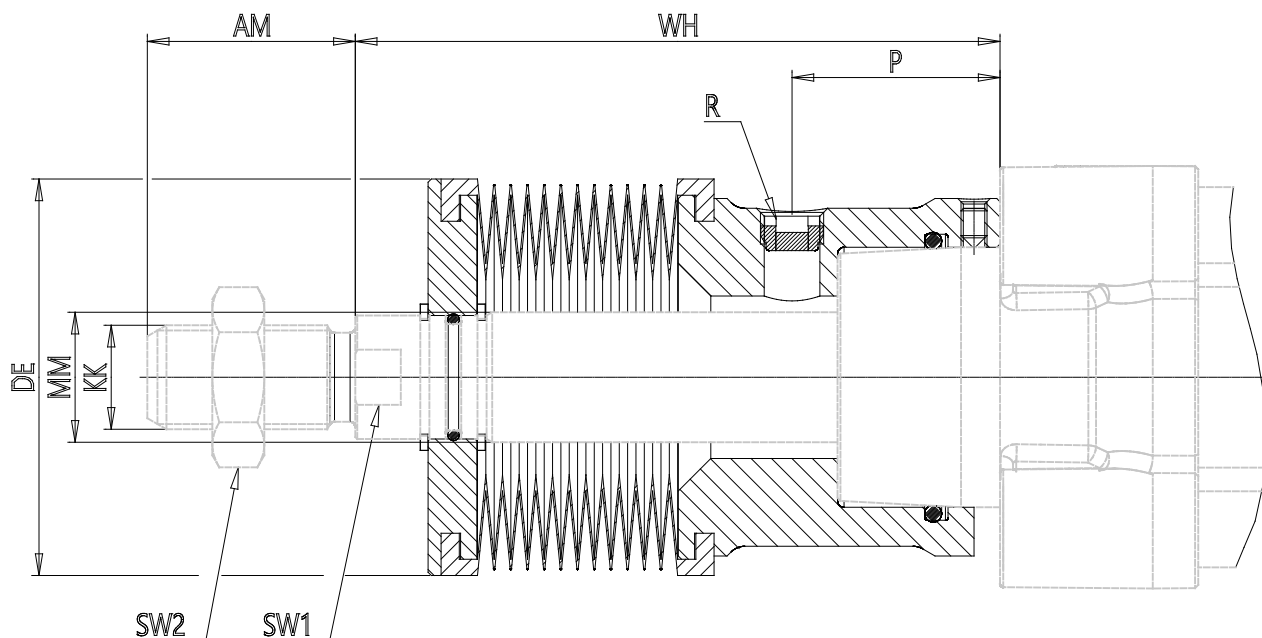

DIMENSIONS

MM (mm)	25
KK	M20x1,5
B (mm)	55
PL (mm)	24.0
L1 (mm)	35
AM (mm)	40
VA (mm)	4
EE	G1/2
WH (mm)	139.000
L2 (mm)	138.0
L3 (mm)	0.0
L4 (mm)	28.0
ZM (mm)	-
ZJ (mm)	189
VD (mm)	7
N (mm)	39.5
BG (mm)	19.5
RT	M10
G (mm)	8.0
TG (mm)	89.0
E (mm)	110.0
SW1 (mm)	22
SW2 (mm)	6

SW3 (mm)	5
SW4 (mm)	30
Cushion stroke (mm)	25
DE (mm)	83
P (mm)	12
R	G1/8
LB (mm)	18.0
D1 (mm)	55.0
D2 (mm)	100
D3 (mm)	58
A (mm)	89.0
G2	G1/8
H (mm)	58.0
H1 (mm)	110.5
L1B (mm)	115
L2B (mm)	100
L3B (mm)	15
L4B (mm)	18
L5B (mm)	20
L6B (mm)	39.0
L7B (mm)	69.0
L8B (mm)	105
L9B (mm)	138