

## Cylinders ISO 15552 - Series 63

Product code: 63MP2C125A0080F

Datasheet creation date: 09/03/2025 12:58

Check the most updated document online [click here](#)



### TECHNICAL DATA

<b>Series</b>	63
<b>Version</b>	M = standard, magnetic
<b>Costrction</b>	P = profile tube
<b>Operation</b>	2 = double effect
<b>Cushioning</b>	C = cushioning on both sides
<b>Bore (mm)</b>	125
<b>Construction</b>	A = standard with lock nut for rod
<b>Stroke type</b>	= standard
<b>X1 ( stroke cylinders) it has to be smaller of X2 (mm)</b>	80
<b>X2 ( stroke cylinders) it has to be greater of X1 (mm)</b>	0
<b>Temperature Range</b>	= standard (-20°/+80°C)
<b>Resistence to corrosion</b>	= standard
<b>Rod variants</b>	F = female rod thread
<b>End caps variants</b>	= standard
<b>Variants of rod seals</b>	= standard
<b>Rod seal protection variants</b>	= standard
<b>Bellow protection variants</b>	= standard
<b>Rod length (mm)</b>	0
<b>Other</b>	= standard
<b>Certifications</b>	= standard

## Cylinders ISO 15552 - Series 63

Product code: 63MP2C125A0080F

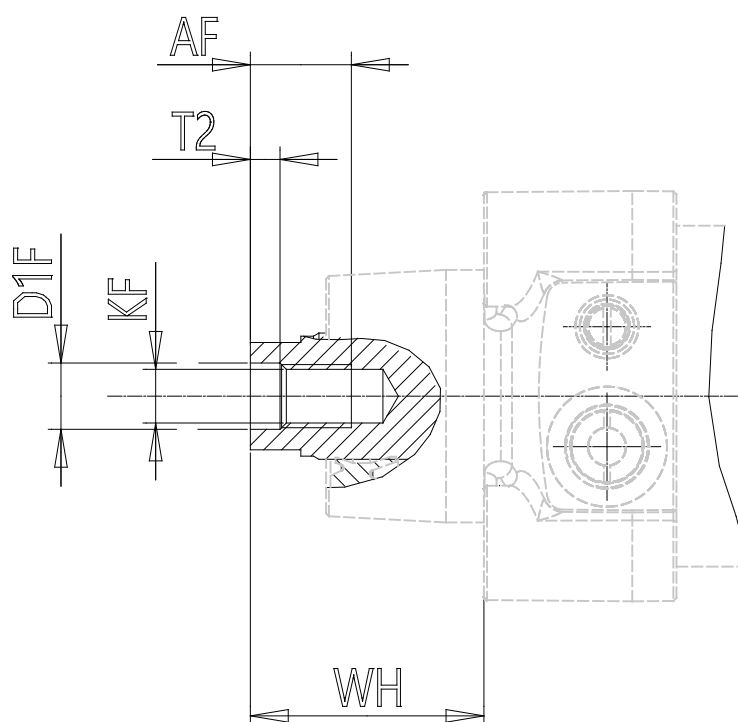

### DIMENSIONS

MM (mm)	32
KK	M27x2
B (mm)	60
PL (mm)	28.0
L1 (mm)	42
AM (mm)	54
VA (mm)	6
EE	G1/2
WH (mm)	65.000
L2 (mm)	160.0
L3 (mm)	6.0
L4 (mm)	0.0
ZM (mm)	-
ZJ (mm)	225
VD (mm)	8
N (mm)	44.0
BG (mm)	23.0
RT	M12
G (mm)	10.5
TG (mm)	110.0
E (mm)	135.0
SW1 (mm)	27
SW2 (mm)	12

SW3 (mm)	4
SW4 (mm)	41
Cushion stroke (mm)	43
DE (mm)	83
P (mm)	30
R	G1/8
LB (mm)	36.5
D1 (mm)	60.0
D2 (mm)	130
D3 (mm)	65
A (mm)	110.0
G2	G1/8
H (mm)	80.0
H1 (mm)	150.0
L1B (mm)	167
L2B (mm)	122
L3B (mm)	45
L4B (mm)	22
L5B (mm)	30
L6B (mm)	51.0
L7B (mm)	86.5
L8B (mm)	140
L9B (mm)	160