

Cylinders ISO 15552 - Series 63

Product code: 63MP2C125A0500B

Datasheet creation date: 09/03/2025 13:03

Check the most updated document online [click here](#)



TECHNICAL DATA

Series	63
Version	M = standard, magnetic
Costrction	P = profile tube
Operation	2 = double effect
Cushioning	C = cushioning on both sides
Bore (mm)	125
Construction	A = standard with lock nut for rod
Stroke type	= standard
X1 (stroke cylinders) it has to be smaller of X2 (mm)	500
X2 (stroke cylinders) it has to be greater of X1 (mm)	0
Temperature Range	= standard (-20°/+80°C)
Resistence to corrosion	= standard
Rod variants	= standard (male thread rod)
End caps variants	= standard
Variants of rod seals	= standard
Rod seal protection variants	= standard
Bellow protection variants	B = cylinder with NBR bellow rod protection
Rod length (mm)	0
Other	= standard
Certifications	= standard

Cylinders ISO 1552 - Series 63

Product code: 63MP2C125A0500B

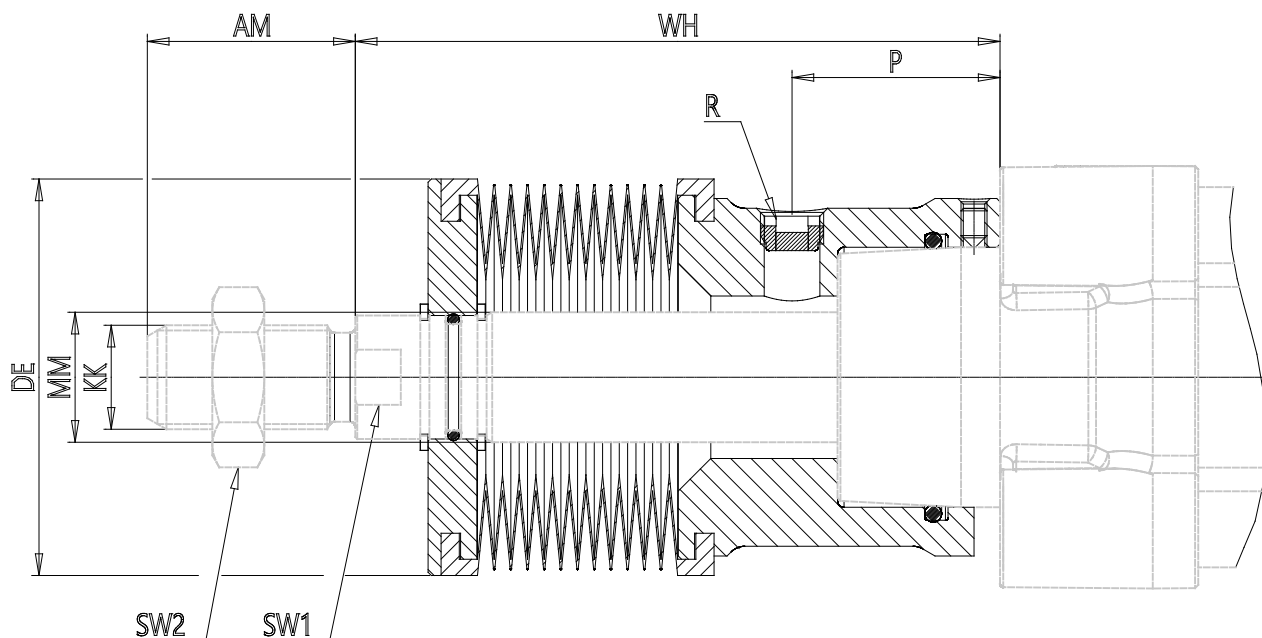

DIMENSIONS

MM (mm)	32
KK	M27x2
B (mm)	60
PL (mm)	28.0
L1 (mm)	42
AM (mm)	54
VA (mm)	6
EE	G1/2
WH (mm)	161.000
L2 (mm)	160.0
L3 (mm)	6.0
L4 (mm)	0.0
ZM (mm)	-
ZJ (mm)	225
VD (mm)	8
N (mm)	44.0
BG (mm)	23.0
RT	M12
G (mm)	10.5
TG (mm)	110.0
E (mm)	135.0
SW1 (mm)	27
SW2 (mm)	12

SW3 (mm)	4
SW4 (mm)	41
Cushion stroke (mm)	43
DE (mm)	83
P (mm)	30
R	G1/8
LB (mm)	36.5
D1 (mm)	60.0
D2 (mm)	130
D3 (mm)	65
A (mm)	110.0
G2	G1/8
H (mm)	80.0
H1 (mm)	150.0
L1B (mm)	167
L2B (mm)	122
L3B (mm)	45
L4B (mm)	22
L5B (mm)	30
L6B (mm)	51.0
L7B (mm)	86.5
L8B (mm)	140
L9B (mm)	160