

## Cylinders ISO 1552 - Series 63

Product code: 63MP6C040A0150

Datasheet creation date: 09/03/2025 13:42

Check the most updated document online [click here](#)



### TECHNICAL DATA

<b>Series</b>	63
<b>Version</b>	M = standard, magnetic
<b>Costrction</b>	P = profile tube
<b>Operation</b>	6 = double acting through rod
<b>Cushioning</b>	C = cushioning on both sides
<b>Bore (mm)</b>	40
<b>Construction</b>	A = standard with lock nut for rod
<b>Stroke type</b>	= standard
<b>X1 ( stroke cylinders) it has to be smaller of X2 (mm)</b>	150
<b>X2 ( stroke cylinders) it has to be greater of X1 (mm)</b>	0
<b>Temperature Range</b>	= standard (-20°/+80°C)
<b>Resistence to corrosion</b>	= standard
<b>Rod variants</b>	= standard (male thread rod)
<b>End caps variants</b>	= standard
<b>Variants of rod seals</b>	= standard
<b>Rod seal protection variants</b>	= standard
<b>Bellow protection variants</b>	= standard
<b>Rod length (mm)</b>	0
<b>Other</b>	= standard
<b>Certifications</b>	= standard

## Cylinders ISO 1552 - Series 63

Product code: 63MP6C040A0150

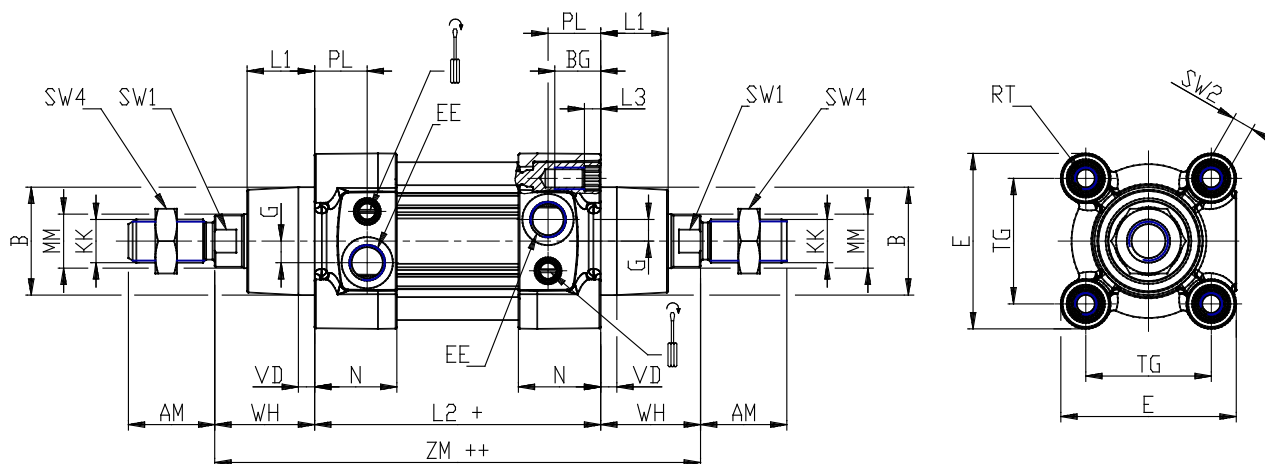

### DIMENSIONS

MM (mm)	16
KK	M12x1,25
B (mm)	35
PL (mm)	19.0
L1 (mm)	21
AM (mm)	24
VA (mm)	-
EE	G1/4
WH (mm)	30.000
L2 (mm)	105.0
L3 (mm)	5.5
L4 (mm)	23.0
ZM (mm)	165
ZJ (mm)	-
VD (mm)	5
N (mm)	30.0
BG (mm)	16.0
RT	M6
G (mm)	5.0
TG (mm)	38.0
E (mm)	55.0
SW1 (mm)	13
SW2 (mm)	6

SW3 (mm)	2
SW4 (mm)	19
Cushion stroke (mm)	22
DE (mm)	61
P (mm)	26
R	M5
LB (mm)	36.6
D1 (mm)	35.0
D2 (mm)	40
D3 (mm)	28
A (mm)	38.0
G2	G1/8
H (mm)	30.0
H1 (mm)	53.0
L1B (mm)	65
L2B (mm)	55
L3B (mm)	10
L4B (mm)	8
L5B (mm)	13
L6B (mm)	22.5
L7B (mm)	38.0
L8B (mm)	50
L9B (mm)	105