

## Cylinders ISO 15552 - Series 63

Product code: 63MP6C050A0090

Datasheet creation date: 09/03/2025 14:25

Check the most updated document online [click here](#)



### TECHNICAL DATA

<b>Series</b>	63
<b>Version</b>	M = standard, magnetic
<b>Costrction</b>	P = profile tube
<b>Operation</b>	6 = double acting through rod
<b>Cushioning</b>	C = cushioning on both sides
<b>Bore (mm)</b>	50
<b>Construction</b>	A = standard with lock nut for rod
<b>Stroke type</b>	- = variable
<b>X1 ( stroke cylinders) it has to be smaller of X2 (mm)</b>	90
<b>X2 ( stroke cylinders) it has to be greater of X1 (mm)</b>	0
<b>Temperature Range</b>	= standard (-20°/+80°C)
<b>Resistance to corrosion</b>	= standard
<b>Rod variants</b>	= standard (male thread rod)
<b>End caps variants</b>	= standard
<b>Variants of rod seals</b>	= standard
<b>Rod seal protection variants</b>	= standard
<b>Bellow protection variants</b>	= standard
<b>Rod length (mm)</b>	0
<b>Other</b>	= standard
<b>Certifications</b>	= standard

## Cylinders ISO 15552 - Series 63

Product code: 63MP6C050A0090

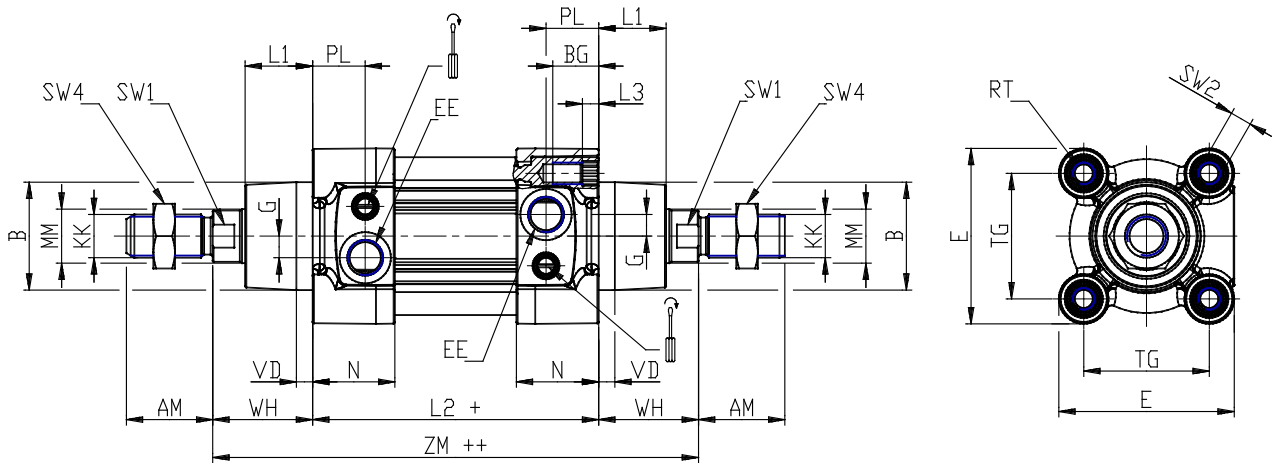

### DIMENSIONS

MM (mm)	20
KK	M16x1,5
B (mm)	40
PL (mm)	19.5
L1 (mm)	25
AM (mm)	32
VA (mm)	-
EE	G1/4
WH (mm)	37.000
L2 (mm)	106.0
L3 (mm)	6.0
L4 (mm)	24.0
ZM (mm)	180
ZJ (mm)	-
VD (mm)	6
N (mm)	30.5
BG (mm)	16.0
RT	M8
G (mm)	8.0
TG (mm)	46.5
E (mm)	65.0
SW1 (mm)	17
SW2 (mm)	8

SW3 (mm)	3
SW4 (mm)	24
Cushion stroke (mm)	22
DE (mm)	61
P (mm)	30
R	M5
LB (mm)	44.0
D1 (mm)	40.0
D2 (mm)	50
D3 (mm)	35
A (mm)	46.5
G2	G1/8
H (mm)	36.0
H1 (mm)	64.0
L1B (mm)	82
L2B (mm)	70
L3B (mm)	12
L4B (mm)	15
L5B (mm)	16
L6B (mm)	29.5
L7B (mm)	48.0
L8B (mm)	60
L9B (mm)	106