

Cylinders ISO 15552 - Series 63

Product code: 63MT2C050TR75/75

Datasheet creation date: 09/03/2025 21:13

Check the most updated document online [click here](#)



TECHNICAL DATA

Series	63
Version	M = standard, magnetic
Costrction	T = round tube
Operation	2 = double effect
Cushioning	C = cushioning on both sides
Bore (mm)	50
Construction	TR = Back to Back cylinder for round tube (x1/x2)
Stroke type	= standard
X1 (stroke cylinders) it has to be smaller of X2 (mm)	75
X2 (stroke cylinders) it has to be greater of X1 (mm)	75
Temperature Range	= standard (-20°/+80°C)
Resistence to corrosion	= standard
Rod variants	= standard (male thread rod)
End caps variants	= standard
Variants of rod seals	= standard
Rod seal protection variants	= standard
Bellow protection variants	= standard
Rod length (mm)	0
Other	= standard
Certifications	= standard

Cylinders ISO 15552 - Series 63

Product code: 63MT2C050TR75/75

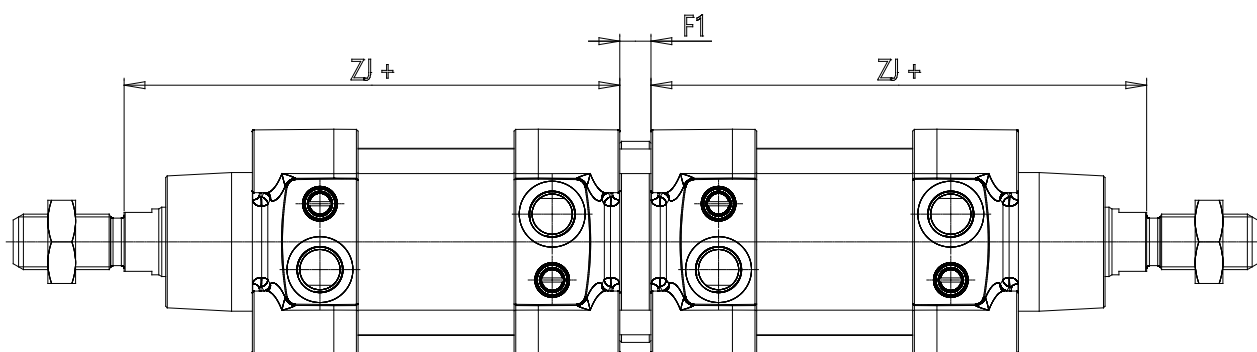

DIMENSIONS

MM (mm)	20
KK	M16x1,5
B (mm)	40
PL (mm)	19.5
L1 (mm)	25
AM (mm)	32
VA (mm)	4
EE	G1/4
WH (mm)	37.000
L2 (mm)	106.0
L3 (mm)	6.0
L4 (mm)	24.0
ZM (mm)	-
ZJ (mm)	143
VD (mm)	6
N (mm)	30.5
BG (mm)	16.0
RT	M8
G (mm)	8.0
TG (mm)	46.5
E (mm)	65.0
SW1 (mm)	17
SW2 (mm)	8

SW3 (mm)	3
SW4 (mm)	24
Cushion stroke (mm)	22
DE (mm)	61
P (mm)	30
R	M5
LB (mm)	44.0
D1 (mm)	40.0
D2 (mm)	50
D3 (mm)	35
A (mm)	46.5
G2	G1/8
H (mm)	36.0
H1 (mm)	64.0
L1B (mm)	82
L2B (mm)	70
L3B (mm)	12
L4B (mm)	15
L5B (mm)	16
L6B (mm)	29.5
L7B (mm)	48.0
L8B (mm)	60
L9B (mm)	106