

## Cylinders ISO 15552 - Series 63

Product code: 63MT2C100F0350

Datasheet creation date: 09/03/2025 14:32

Check the most updated document online [click here](#)



### TECHNICAL DATA

<b>Series</b>	63
<b>Version</b>	M = standard, magnetic
<b>Costrction</b>	T = round tube
<b>Operation</b>	2 = double effect
<b>Cushioning</b>	C = cushioning on both sides
<b>Bore (mm)</b>	100
<b>Construction</b>	F = cylinder with centre trunnion
<b>Stroke type</b>	- = variable
<b>X1 ( stroke cylinders) it has to be smaller of X2 (mm)</b>	350
<b>X2 ( stroke cylinders) it has to be greater of X1 (mm)</b>	0
<b>Temperature Range</b>	= standard (-20°/+80°C)
<b>Resistance to corrosion</b>	= standard
<b>Rod variants</b>	= standard (male thread rod)
<b>End caps variants</b>	= standard
<b>Variants of rod seals</b>	= standard
<b>Rod seal protection variants</b>	= standard
<b>Bellow protection variants</b>	= standard
<b>Rod length (mm)</b>	0
<b>Other</b>	= standard
<b>Certifications</b>	= standard

## Cylinders ISO 15552 - Series 63

Product code: 63MT2C100F0350

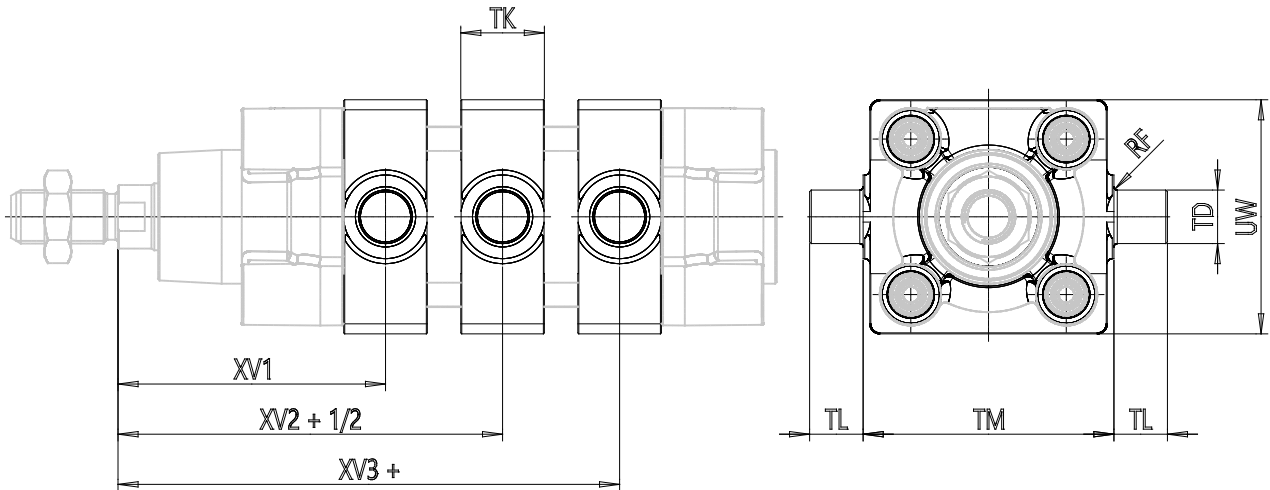

### DIMENSIONS

MM (mm)	25
KK	M20x1,5
B (mm)	55
PL (mm)	24.0
L1 (mm)	35
AM (mm)	40
VA (mm)	4
EE	G1/2
WH (mm)	51.000
L2 (mm)	138.0
L3 (mm)	0.0
L4 (mm)	28.0
ZM (mm)	-
ZJ (mm)	189
VD (mm)	7
N (mm)	39.5
BG (mm)	19.5
RT	M10
G (mm)	8.0
TG (mm)	89.0
E (mm)	110.0
SW1 (mm)	22
SW2 (mm)	6

SW3 (mm)	5
SW4 (mm)	30
Cushion stroke (mm)	25
DE (mm)	83
P (mm)	12
R	G1/8
LB (mm)	18.0
D1 (mm)	55.0
D2 (mm)	100
D3 (mm)	58
A (mm)	89.0
G2	G1/8
H (mm)	58.0
H1 (mm)	110.5
L1B (mm)	115
L2B (mm)	100
L3B (mm)	15
L4B (mm)	18
L5B (mm)	20
L6B (mm)	39.0
L7B (mm)	69.0
L8B (mm)	105
L9B (mm)	138