

## Mod. 6430 - Fittings Serie 6000 inch

Product code: 6430 04-04

Datasheet creation date: 10/03/2025 09:24

Check the most updated document online [click here](#)



### TECHNICAL DATA

Mod.	6430 04-04
------	------------

## Mod. 6430 - Fittings Serie 6000 inch

Product code: 6430 04-04

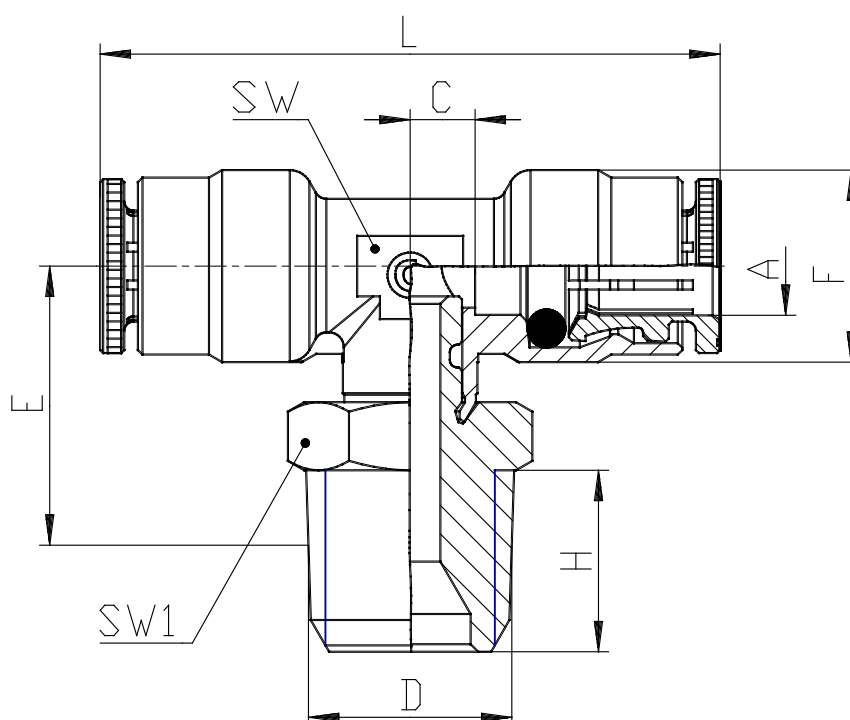

### DIMENSIONS

<b>A</b>	1/4
<b>D</b>	1/4
<b>C (INCH)</b>	0.169
<b>E (INCH)</b>	0.630
<b>F (INCH)</b>	0.500
<b>H (INCH)</b>	0.472
<b>L (INCH)</b>	1.614
<b>SW (INCH)</b>	0.354
<b>SW1 (INCH)</b>	0.551