

Mod. 6430 - Fittings Serie 6000 inch

Product code: 6430 06-06

Datasheet creation date: 10/03/2025 09:25

Check the most updated document online [click here](#)



TECHNICAL DATA

Mod.	6430 06-06
------	------------

Mod. 6430 - Fittings Serie 6000 inch

Product code: 6430 06-06

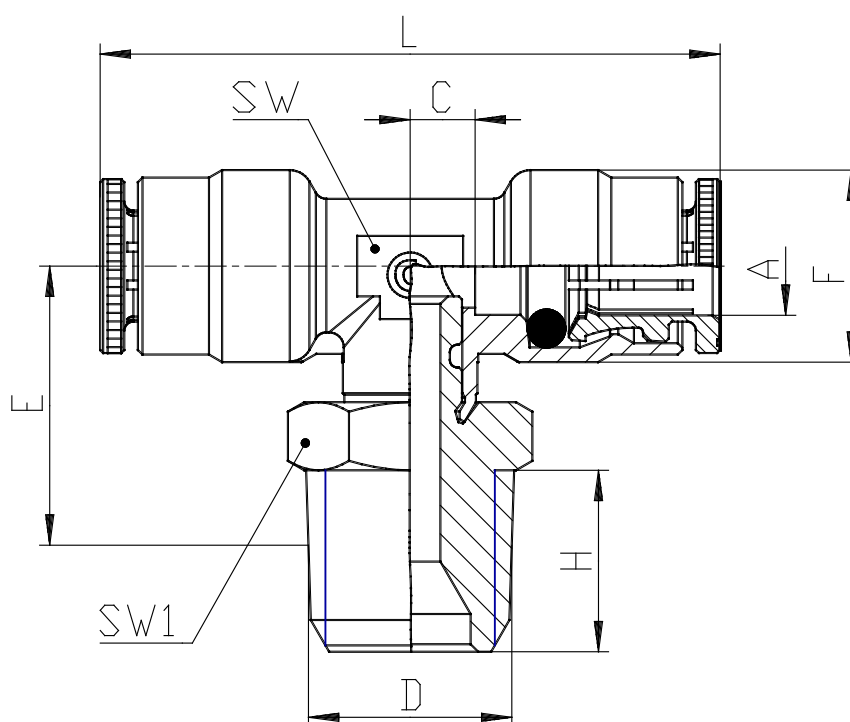

DIMENSIONS

A	3/8
D	3/8
C (INCH)	0.236
E (INCH)	0.787
F (INCH)	0.650
H (INCH)	0.472
L (INCH)	2.047
SW (INCH)	0.512
SW1 (INCH)	0.748