

## Mod. 6430 - Fittings Serie 6000 inch

Product code: 6430 08-06

Datasheet creation date: 10/03/2025 09:24

Check the most updated document online [click here](#)



### TECHNICAL DATA

Mod.	6430 08-06
------	------------

## Mod. 6430 - Fittings Serie 6000 inch

Product code: 6430 08-06

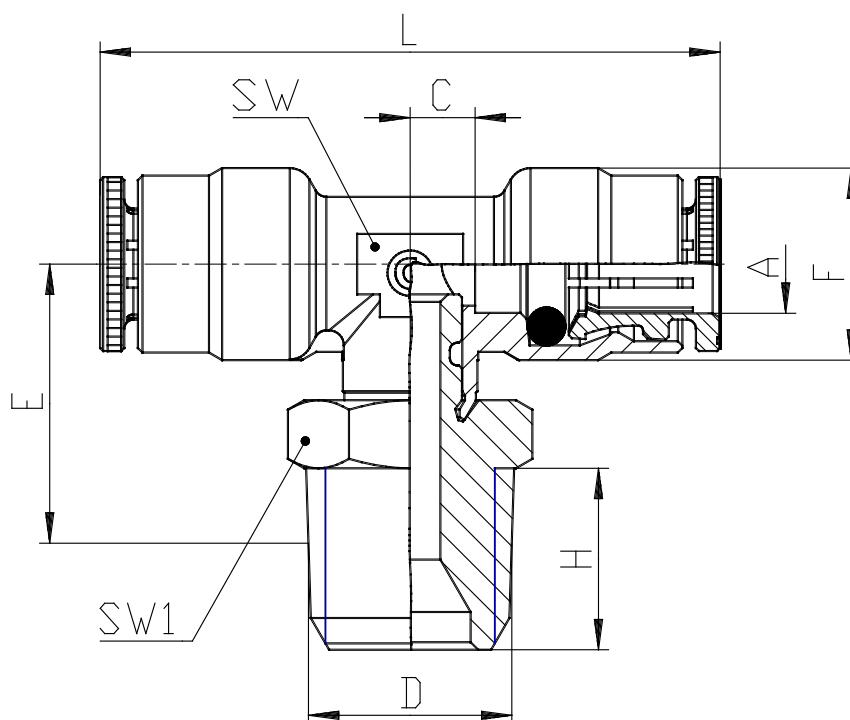

### DIMENSIONS

<b>A</b>	1/2
<b>D</b>	3/8
<b>C (INCH)</b>	0.287
<b>E (INCH)</b>	0.827
<b>F (INCH)</b>	0.776
<b>H (INCH)</b>	0.472
<b>L (INCH)</b>	2.087
<b>SW (INCH)</b>	0.591
<b>SW1 (INCH)</b>	0.748