

Mod. 6430 - Fittings Serie 6000 inch

Product code: 6430 08-08

Datasheet creation date: 10/03/2025 09:24

Check the most updated document online [click here](#)



TECHNICAL DATA

Mod.	6430 08-08
------	------------

Mod. 6430 - Fittings Serie 6000 inch

Product code: 6430 08-08

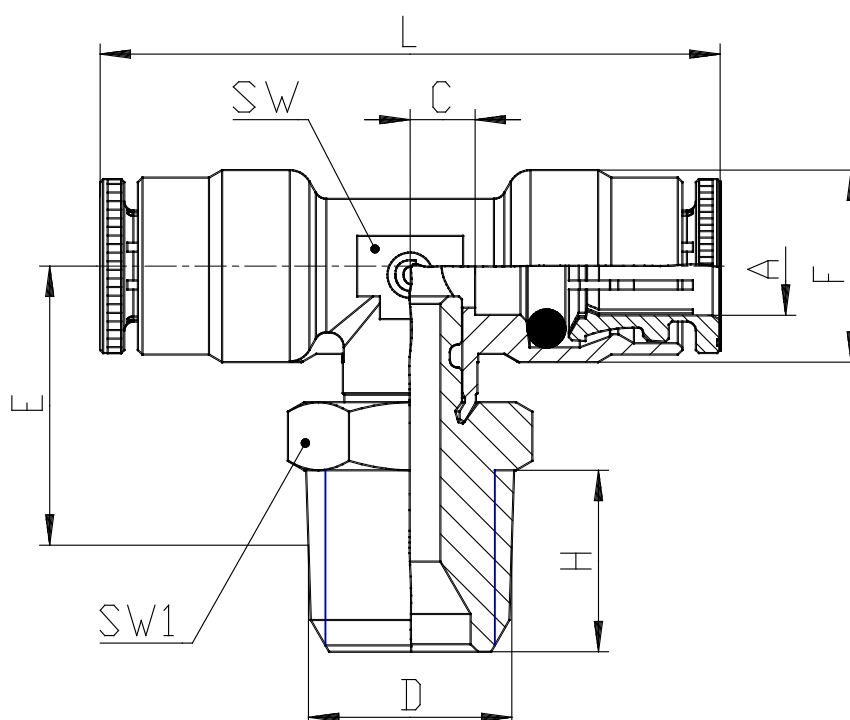

DIMENSIONS

A	1/2
D	1/2
C (INCH)	0.287
E (INCH)	0.846
F (INCH)	0.776
H (INCH)	0.610
L (INCH)	2.087
SW (INCH)	0.591
SW1 (INCH)	0.866