

Mod. 6440 - Fittings Serie 6000 inch

Product code: 6440 04-06

Datasheet creation date: 10/03/2025 09:26

Check the most updated document online [click here](#)



TECHNICAL DATA

Mod.	6440 04-06
------	------------

Mod. 6440 - Fittings Serie 6000 inch

Product code: 6440 04-06

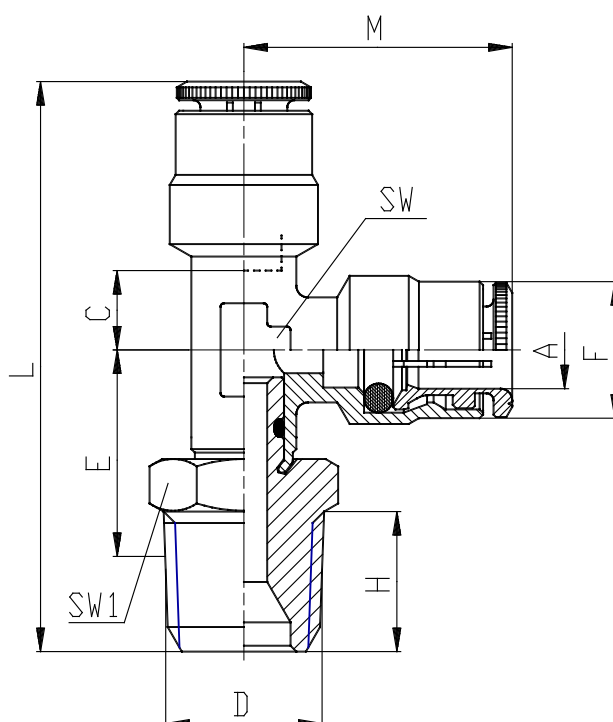

DIMENSIONS

A	1/4
D	3/8
C (INCH)	0.169
E (INCH)	0.650
F (INCH)	0.500
H (INCH)	0.472
L (INCH)	9.957
SW (INCH)	0.354
SW1 (INCH)	0.748