

Mod. 6440 - Fittings Serie 6000 inch

Product code: 6440 06-04

Datasheet creation date: 10/03/2025 09:26

Check the most updated document online [click here](#)



TECHNICAL DATA

Mod.	6440 06-04
------	------------

Mod. 6440 - Fittings Serie 6000 inch

Product code: 6440 06-04

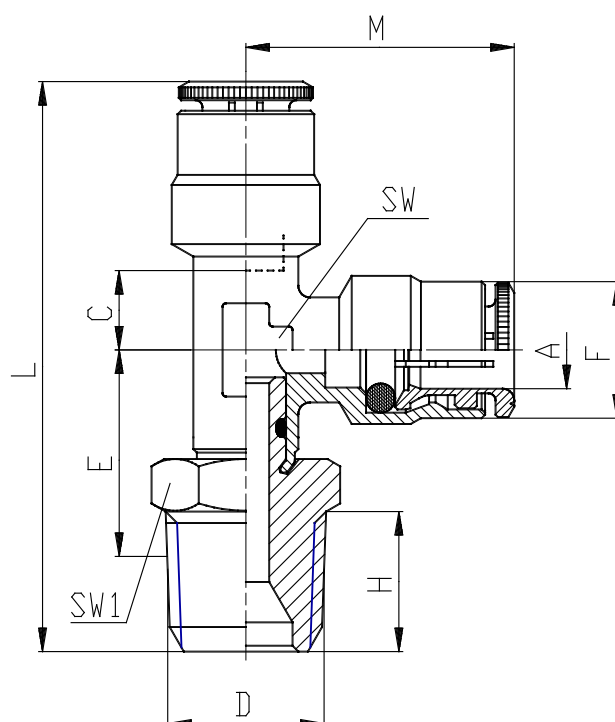

DIMENSIONS

A	3/8
D	1/4
C (INCH)	0.236
E (INCH)	0.748
F (INCH)	0.650
H (INCH)	0.472
L (INCH)	9.272
SW (INCH)	0.512
SW1 (INCH)	0.551