

## Mod. 6440 - Fittings Serie 6000 inch

Product code: 6440 08-08

Datasheet creation date: 10/03/2025 09:25

Check the most updated document online [click here](#)



### TECHNICAL DATA

Mod.	6440 08-08
------	------------

## Mod. 6440 - Fittings Serie 6000 inch

Product code: 6440 08-08

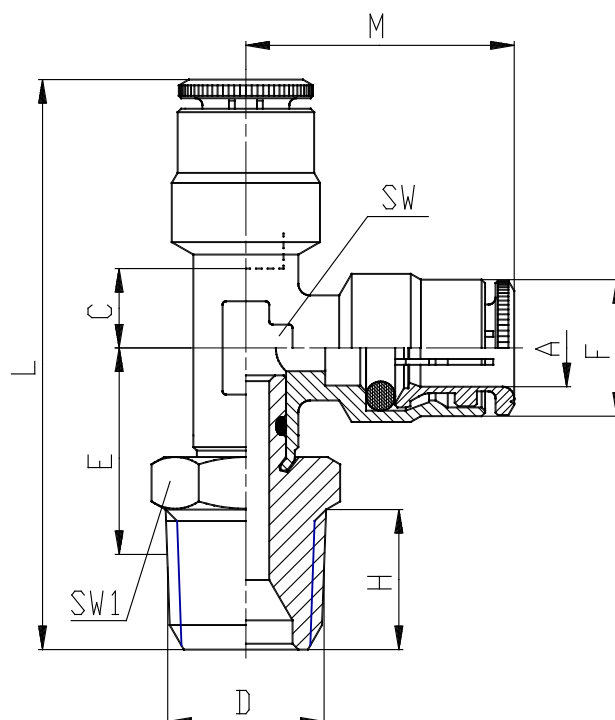

### DIMENSIONS

<b>A</b>	1/2
<b>D</b>	1/2
<b>C (INCH)</b>	0.287
<b>E (INCH)</b>	0.846
<b>F (INCH)</b>	0.776
<b>H (INCH)</b>	0.610
<b>L (INCH)</b>	12.390
<b>SW (INCH)</b>	0.591
<b>SW1 (INCH)</b>	0.866