

## Mod. 6510 - Fittings Serie 6000 inch

Product code: 6510 04-04

Datasheet creation date: 10/03/2025 09:28

Check the most updated document online [click here](#)



### ■ TECHNICAL DATA

Mod.	6510 04-04
------	------------

## Mod. 6510 - Fittings Serie 6000 inch

Product code: 6510 04-04

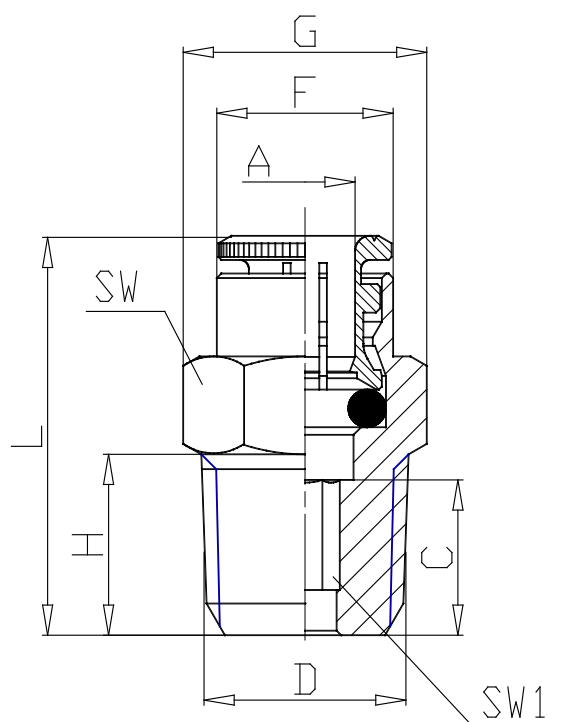

### DIMENSIONS

<b>A</b>	1/4
<b>D</b>	1/4
<b>C (INCH)</b>	0.406
<b>F (INCH)</b>	0.461
<b>G (INCH)</b>	0.630
<b>H (INCH)</b>	0.472
<b>L (INCH)</b>	1.043
<b>SW (INCH)</b>	0.551
<b>SW1 (INCH)</b>	0.157
<b>ND (INCH)</b>	0.540