

Mod. 6510 - Fittings Serie 6000 inch

Product code: 6510 04-06

Datasheet creation date: 10/03/2025 09:28

Check the most updated document online [click here](#)



■ TECHNICAL DATA

Mod.	6510 04-06
------	------------

Mod. 6510 - Fittings Serie 6000 inch

Product code: 6510 04-06

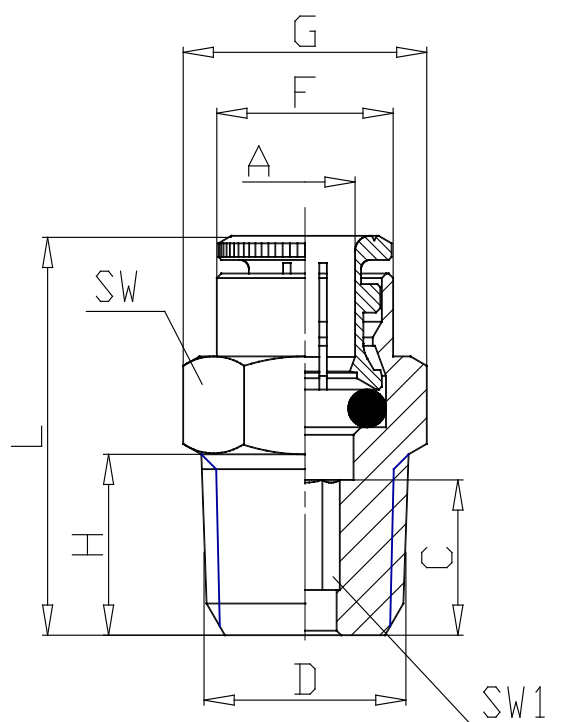

DIMENSIONS

A	1/4
D	3/8
C (INCH)	0.425
F (INCH)	0.461
G (INCH)	0.866
H (INCH)	0.472
L (INCH)	1.063
SW (INCH)	0.748
SW1 (INCH)	0.157
ND (INCH)	0.675