

## Mod. 6510 - Fittings Serie 6000 inch

Product code: 6510 06-04

Datasheet creation date: 10/03/2025 09:28

Check the most updated document online [click here](#)



### ■ TECHNICAL DATA

Mod.	6510 06-04
------	------------

## Mod. 6510 - Fittings Serie 6000 inch

Product code: 6510 06-04

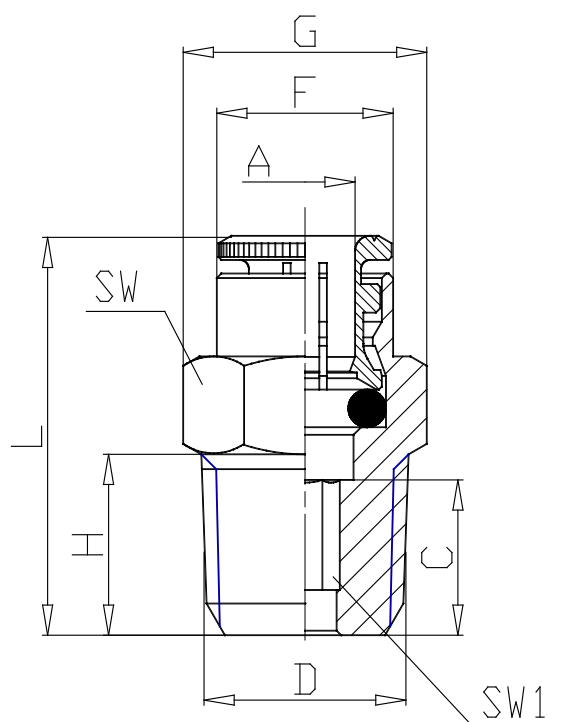

### DIMENSIONS

<b>A</b>	3/8
<b>D</b>	1/4
<b>C (INCH)</b>	0.551
<b>F (INCH)</b>	0.606
<b>G (INCH)</b>	0.776
<b>H (INCH)</b>	0.472
<b>L (INCH)</b>	1.339
<b>SW (INCH)</b>	0.669
<b>SW1 (INCH)</b>	0.276
<b>ND (INCH)</b>	0.540