

Mod. 6510 - Fittings Serie 6000 inch

Product code: 6510 06-08

Datasheet creation date: 10/03/2025 09:28

Check the most updated document online [click here](#)



■ TECHNICAL DATA

Mod.	6510 06-08
------	------------

Mod. 6510 - Fittings Serie 6000 inch

Product code: 6510 06-08

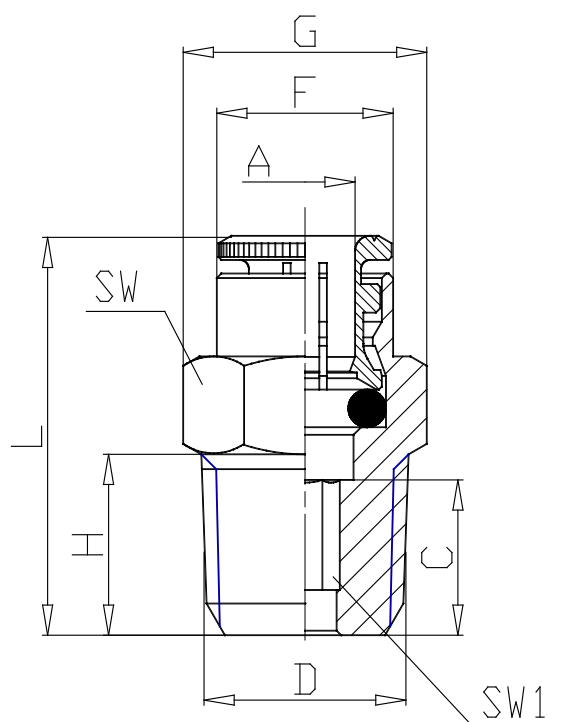

DIMENSIONS

A	3/8
D	1/2
C (INCH)	0.571
F (INCH)	0.606
G (INCH)	1.004
H (INCH)	0.610
L (INCH)	1.161
SW (INCH)	0.866
SW1 (INCH)	0.276
ND (INCH)	0.840