

## Mod. 6510 - Fittings Serie 6000 inch

Product code: 6510 08-06

Datasheet creation date: 10/03/2025 09:28

Check the most updated document online [click here](#)



### ■ TECHNICAL DATA

Mod.	6510 08-06
------	------------

## Mod. 6510 - Fittings Serie 6000 inch

Product code: 6510 08-06

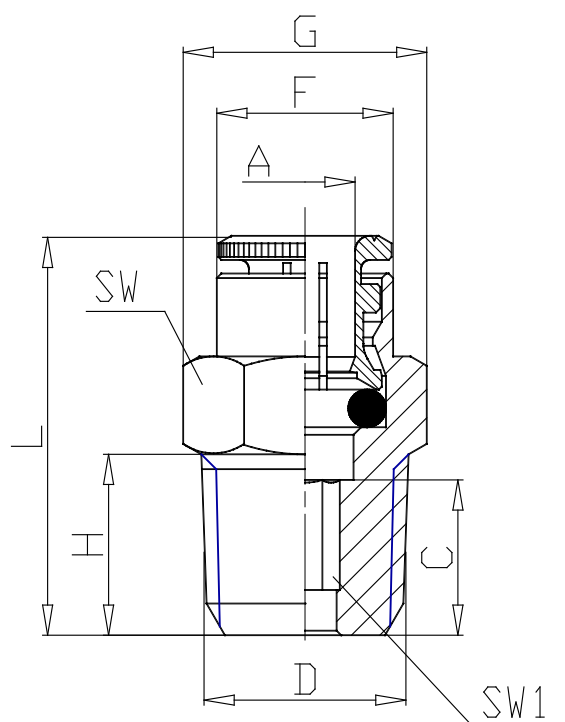

### DIMENSIONS

<b>A</b>	1/2
<b>D</b>	3/8
<b>C (INCH)</b>	0.484
<b>F (INCH)</b>	0.720
<b>G (INCH)</b>	0.866
<b>H (INCH)</b>	0.472
<b>L (INCH)</b>	1.240
<b>SW (INCH)</b>	0.748
<b>SW1 (INCH)</b>	0.394
<b>ND (INCH)</b>	0.675