

Mod. 6510 - Fittings Serie 6000 inch

Product code: 6510 08-08

Datasheet creation date: 10/03/2025 09:28

Check the most updated document online [click here](#)



TECHNICAL DATA

Mod.	6510 08-08
------	------------

Mod. 6510 - Fittings Serie 6000 inch

Product code: 6510 08-08

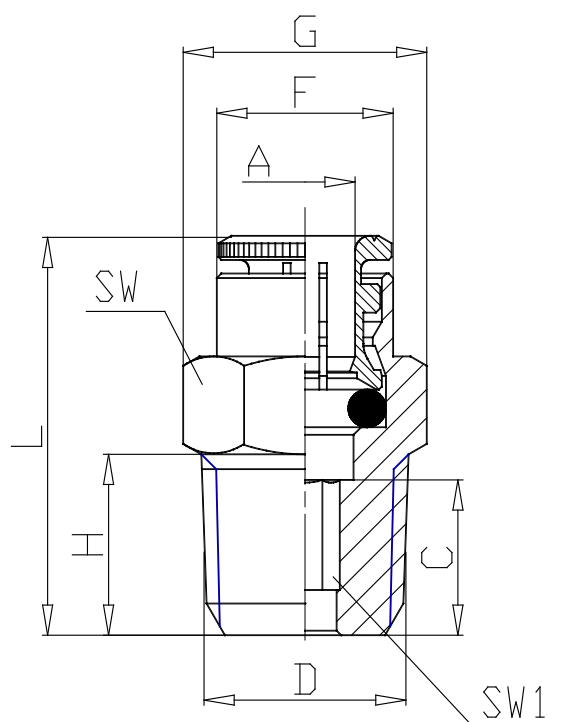

DIMENSIONS

A	1/2
D	1/2
C (INCH)	0.425
F (INCH)	0.720
G (INCH)	1.004
H (INCH)	0.610
L (INCH)	1.181
SW (INCH)	0.866
SW1 (INCH)	0.394
ND (INCH)	0.840