

## Mod. 6520 - Fittings Serie 6000 inch

Product code: 6520 04-06

Datasheet creation date: 10/03/2025 09:30

Check the most updated document online [click here](#)



### TECHNICAL DATA

Mod.	6520 04-06
------	------------

## Mod. 6520 - Fittings Serie 6000 inch

Product code: 6520 04-06

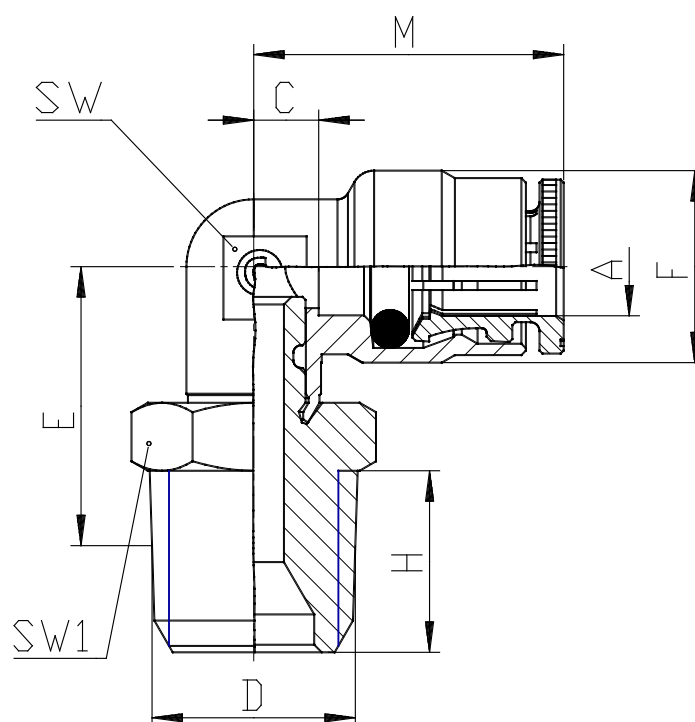

### DIMENSIONS

<b>A</b>	1/4
<b>D</b>	3/8
<b>C (INCH)</b>	0.169
<b>E (INCH)</b>	0.650
<b>F (INCH)</b>	0.500
<b>H (INCH)</b>	0.472
<b>M (INCH)</b>	0.807
<b>SW (INCH)</b>	0.354
<b>SW1 (INCH)</b>	0.748