

## Mod. 6520 - Fittings Serie 6000 inch

Product code: 6520 06-04

Datasheet creation date: 10/03/2025 09:31

Check the most updated document online [click here](#)



### TECHNICAL DATA

Mod.	6520 06-04
------	------------

## Mod. 6520 - Fittings Serie 6000 inch

Product code: 6520 06-04

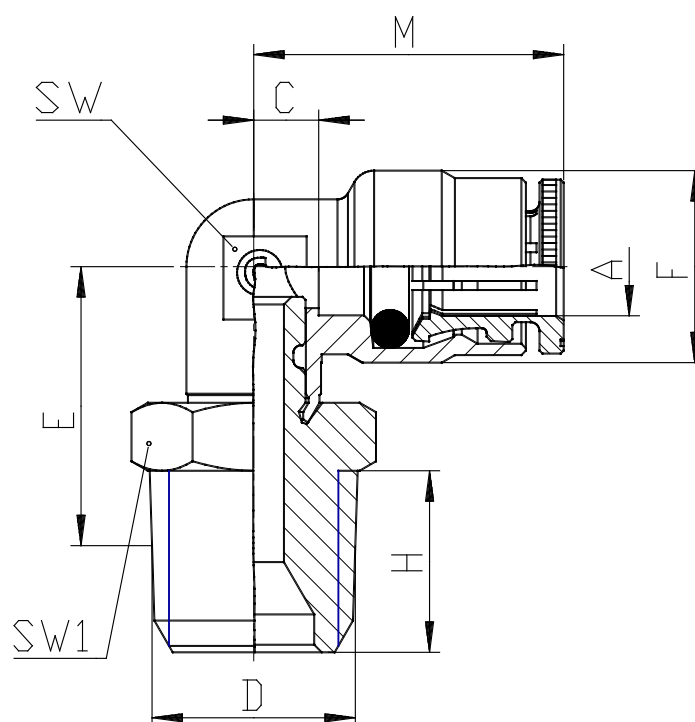

### DIMENSIONS

<b>A</b>	3/8
<b>D</b>	1/4
<b>C (INCH)</b>	0.236
<b>E (INCH)</b>	0.748
<b>F (INCH)</b>	0.650
<b>H (INCH)</b>	0.472
<b>M (INCH)</b>	1.024
<b>SW (INCH)</b>	0.512
<b>SW1 (INCH)</b>	0.551