

Mod. 6590 - Series 6000 fittings

Product code: 6590 4

Datasheet creation date: 10/03/2025 09:34

Check the most updated document online [click here](#)



TECHNICAL DATA

Mod.	6590 4
------	--------

Mod. 6590 - Series 6000 fittings

Product code: 6590 4

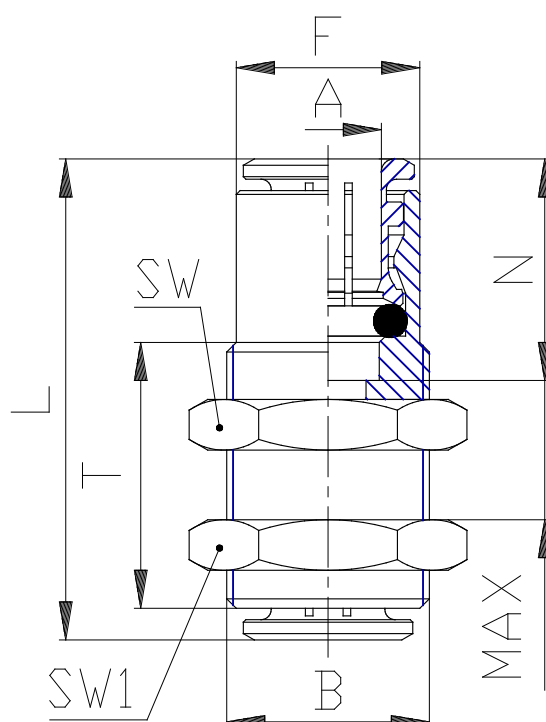

DIMENSIONS

A (mm)	4
B	M10x1
F (mm)	8.8
L (mm)	29.0
N (mm)	14.0
SW (mm)	14
SW1 (mm)	14
T (mm)	20.0