

Mod. 6590 - Series 6000 fittings

Product code: 6590 5

Datasheet creation date: 25/03/2025 09:25

Check the most updated document online [click here](#)



TECHNICAL DATA

Mod.	6590 5
------	--------

Mod. 6590 - Series 6000 fittings

Product code: 6590 5

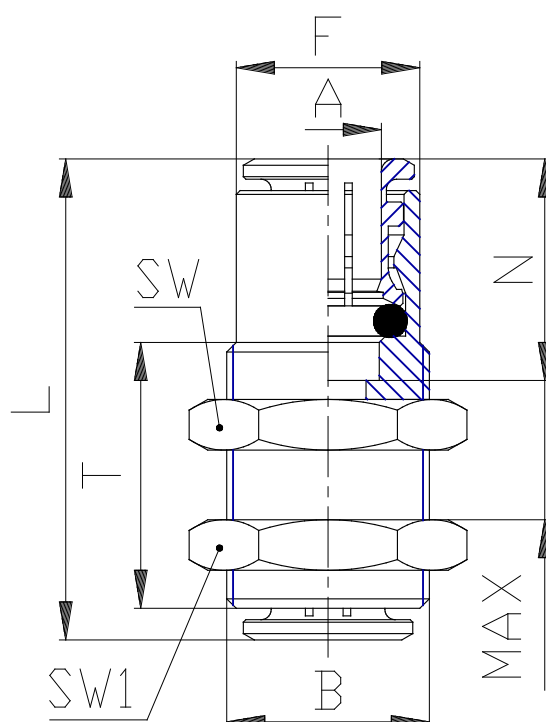

DIMENSIONS

A (mm)	5
B	M12x1
F (mm)	9.8
L (mm)	31.0
N (mm)	15.0
SW (mm)	17
SW1 (mm)	17
T (mm)	20.0