

Rotary cylinders - Series 69

Product code: 69-032/120-F

Datasheet creation date: 07/03/2025 17:47

Check the most updated document online [click here](#)



TECHNICAL DATA

Series	69
Diameter (mm)	32
Rotation (°)	120
Pinion	F=female pinion
Seals material	= NBR

Rotary cylinders - Series 69

Product code: 69-032/120-F

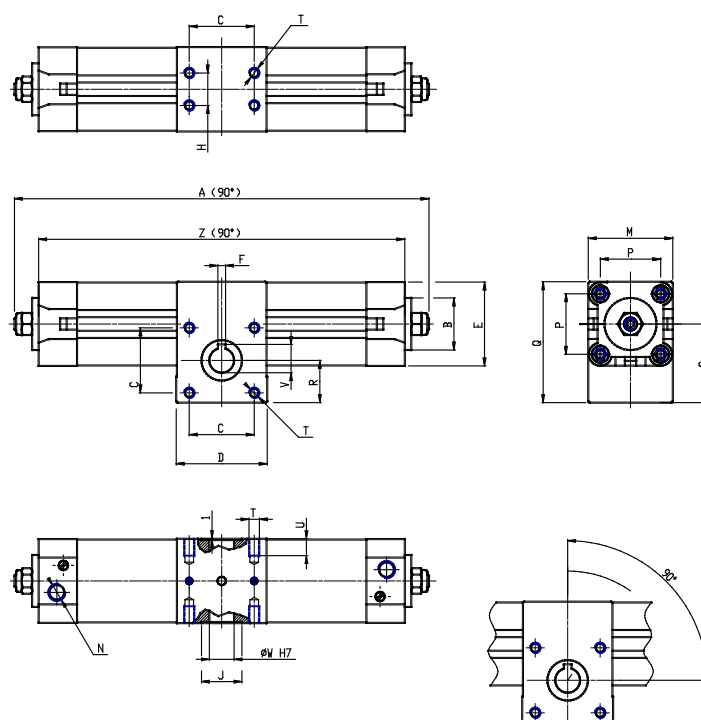

DIMENSIONS

A (mm)	264.7
B d11 (mm)	30
C (mm)	33
D (mm)	50
E (mm)	46.0
F (mm)	5
G (mm)	14
H (mm)	18
J (mm)	25
K (mm)	25
L (mm)	31
M (mm)	50
N	G1/8
P (mm)	32.5
Q (mm)	71.5
R (mm)	25.0
S (mm)	46.5
T	M6
U (mm)	10
V (mm)	16.3
W (mm)	14
Y	M5
X (mm)	12.5
Z (mm)	234.7