

Rotary cylinders - Series 69

Product code: 69-040/270-F

Datasheet creation date: 07/03/2025 17:48

Check the most updated document online [click here](#)



TECHNICAL DATA

Series	69
Diameter (mm)	40
Rotation (°)	270
Pinion	F=female pinion
Seals material	= NBR

Rotary cylinders - Series 69

Product code: 69-040/270-F

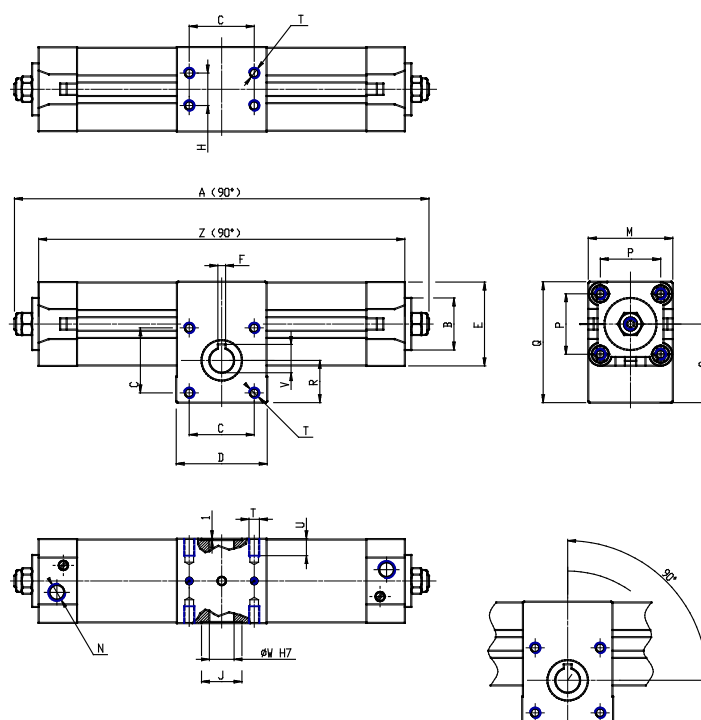

DIMENSIONS

A (mm)	408.0
B d11 (mm)	35
C (mm)	40
D (mm)	60
E (mm)	55.0
F (mm)	5
G (mm)	14
H (mm)	22
J (mm)	25
K (mm)	25
L (mm)	31
M (mm)	60
N	G1/4
P (mm)	38.0
Q (mm)	82.0
R (mm)	30.0
S (mm)	54.5
T	M6
U (mm)	10
V (mm)	16.3
W (mm)	14
Y	M5
X (mm)	12.5
Z (mm)	376.0