

Rotary cylinders - Series 69

Product code: 69-050/100-F

Datasheet creation date: 07/03/2025 17:48

Check the most updated document online [click here](#)



TECHNICAL DATA

Series	69
Diameter (mm)	50
Rotation (°)	100
Pinion	F=female pinion
Seals material	= NBR

Rotary cylinders - Series 69

Product code: 69-050/100-F

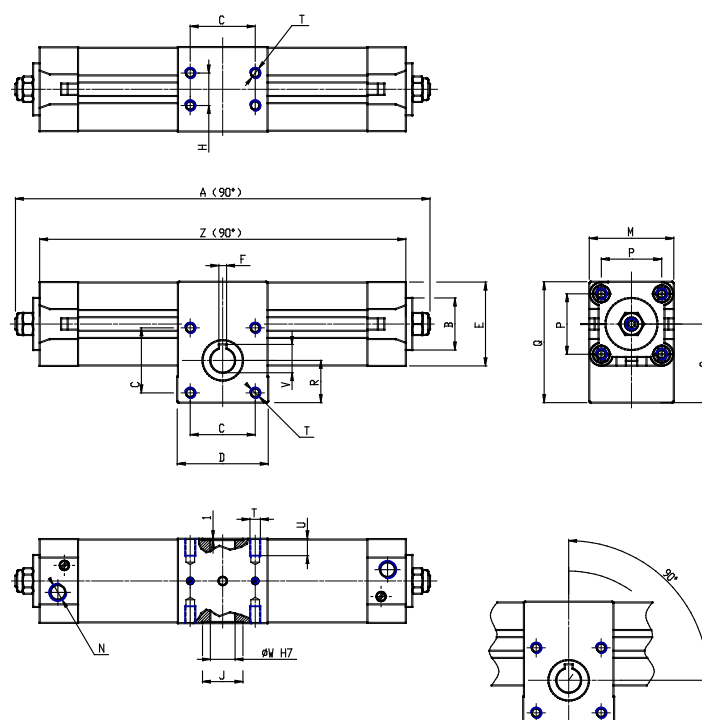

DIMENSIONS

A (mm)	323.0
B d11 (mm)	40
C (mm)	50
D (mm)	70
E (mm)	64.5
F (mm)	6
G (mm)	19
H (mm)	25
J (mm)	30
K (mm)	35
L (mm)	41
M (mm)	65
N	G1/4
P (mm)	46.5
Q (mm)	94.0
R (mm)	32.5
S (mm)	60.5
T	M8
U (mm)	13
V (mm)	21.8
W (mm)	19
Y	M6
X (mm)	16.0
Z (mm)	289.0