

## Rotary cylinders - Series 69

Product code: 69-050/180-F

Datasheet creation date: 07/03/2025 17:49

Check the most updated document online [click here](#)



### TECHNICAL DATA

<b>Series</b>	69
<b>Diameter (mm)</b>	50
<b>Rotation (°)</b>	180
<b>Pinion</b>	F=female pinion
<b>Seals material</b>	= NBR

## Rotary cylinders - Series 69

Product code: 69-050/180-F

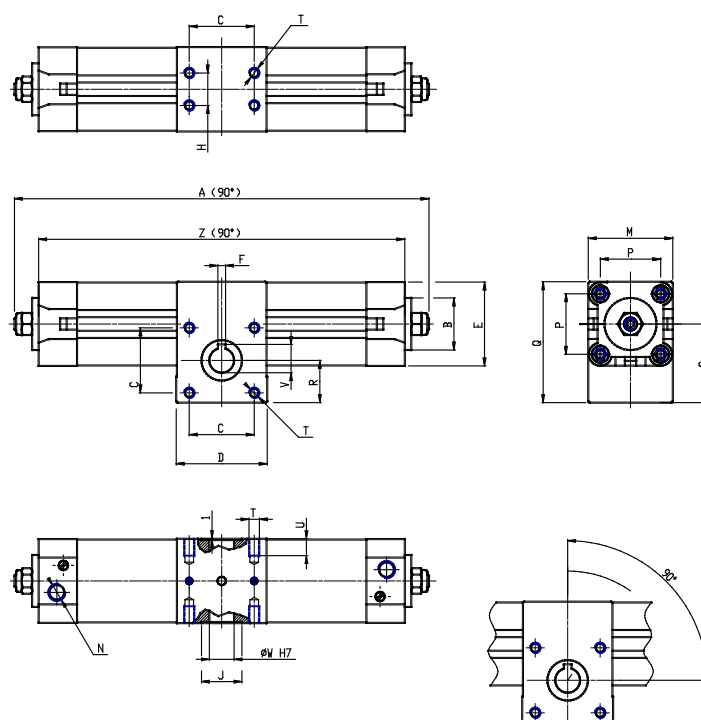

### DIMENSIONS

A (mm)	379.0
B d11 (mm)	40
C (mm)	50
D (mm)	70
E (mm)	64.5
F (mm)	6
G (mm)	19
H (mm)	25
J (mm)	30
K (mm)	35
L (mm)	41
M (mm)	65
N	G1/4
P (mm)	46.5
Q (mm)	94.0
R (mm)	32.5
S (mm)	60.5
T	M8
U (mm)	13
V (mm)	21.8
W (mm)	19
Y	M6
X (mm)	16.0
Z (mm)	345.0